



Grayhill, Inc.

62S11-H9-060SH

Číslo dielu:

62S11-H9-060SH

Výrobca / Značka:

Grayhill, Inc.

Popis produktu

ROTARY ENCODER OPTICAL 32PPR

listoch:

 62S11-H9-060SH.pdf

Stav RoHS

 Bezolovnatý / V súlade RoHS

Odoslať z

Hong Kong

Cesta zásielky

DHL/Fedex/TNT/UPS/EMS

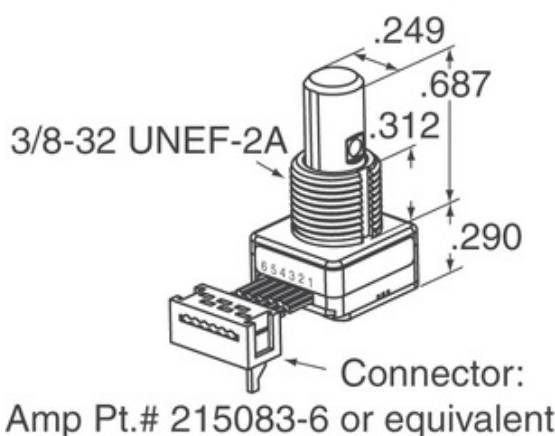

Obraz môže byť reprezentovaný. Pozrite si špecifikácie pre podrobnosti o produktoch.



Špecifikácie 62S11-H9-060SH

ČÍSLO DIELU	62S11-H9-060SH
VÝROBCA	Grayhill, Inc.
POPIS	ROTARY ENCODER OPTICAL 32PPR
STAV VOL'NÉHO VODIČA / ROHS	Bezolovnatý / V súlade RoHS
DÁTOVÝ HÁROK	 62S11-H9-060SH.pdf
NAPÄTIE - NAPÁJANIE	5V
STÝL UKONČENIA	Cable Leads
SÉRIA	62S
ROTAČNÁ ŽIVOTNOSŤ (CYKLY MIN)	1M
IMPULZY NA REVOLÚCIU	32
TYP VÝSTUPU	Quadrature (Incremental)
OSTATNÉ MENÁ	62S11H9060SH
ORIENTÁCIA	Vertical
TYP MONTÁŽE	Panel Mount
ÚROVEŇ CITLIVOSTI NA VLHKOSŤ (MSL)	1 (Unlimited)
VÝROBCA ŠTANDARDNÁ DOBA VÝROBY	8 Weeks
STAV VOL'NÉHO VODIČA / ROHS	Lead free / RoHS Compliant
TYP KÓDOVAČA	Optical
ARETÁCIA	Yes
ZABUDOVANÝ PREPÍNAČ	Yes
TYP POHONU	1/4" Dia Flatted End

Súvisiace značky

Grayhill, Inc. 62S11-H9-060SH	Distribútor 62S11-H9-060SH	Dodávateľ 62S11-H9-060SH
Cena 62S11-H9-060SH	Obrázky 62S11-H9-060SH	Obrázok 62S11-H9-060SH
62S11-H9-060SH PDF list	62S11-H9-060SH Dátový list na stiahnutie	62S11-H9-060SH Dátový list
Zásoba 62S11-H9-060SH	Kúpiť 62S11-H9-060SH	Kúpiť Grayhill, Inc. 62S11-H9-060SH
Grayhill, Inc. 62S11-H9-060SH	Dodávateľ Grayhill, Inc.	Grayhill, Inc. Distribútor
Grayhill, Inc. 62S11-H9-060SH	Grayhill Inc. 62S11-H9-060SH	

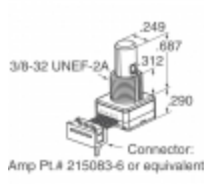
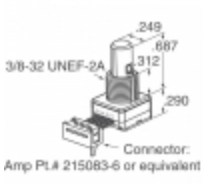
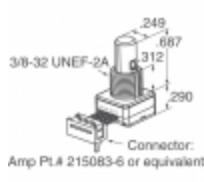
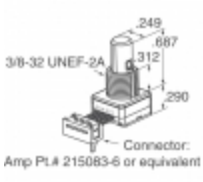
Súvisiace produkty

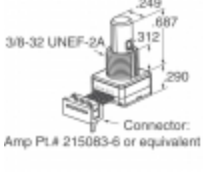
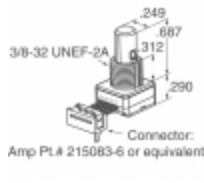
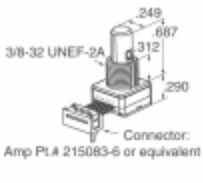
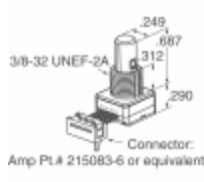
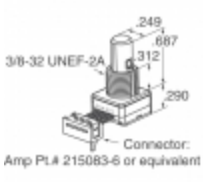
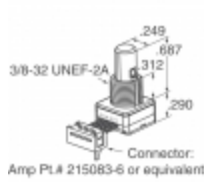
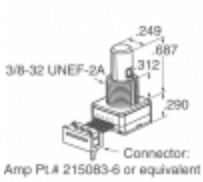
 <p>62S11-L0-040C výrobcovia: Grayhill, Inc. popis: ROTARY ENCODER OPTICAL 32PPR Skladom: Out stock</p> <p>RFQ</p>	 <p>62S11-H9-050S výrobcovia: Grayhill, Inc. popis: ROTARY ENCODER OPTICAL 32PPR Skladom: Out stock</p> <p>RFQ</p>
 <p>62S11-L0-020C výrobcovia: Grayhill, Inc. popis: ROTARY ENCODER OPTICAL 32PPR Skladom: Out stock</p> <p>RFQ</p>	 <p>62S11-L0-020CH výrobcovia: Grayhill, Inc. popis: ROTARY ENCODER OPTICAL 32PPR Skladom: Out stock</p> <p>RFQ</p>
 <p>62S11-L0-040S výrobcovia: Grayhill, Inc. popis: ROTARY ENCODER OPT 32PPR 4" CBL Skladom: Out stock</p> <p>RFQ</p>	 <p>62S11-H9-040S výrobcovia: Grayhill, Inc. popis: ROTARY ENCODER OPTICAL 32PPR Skladom: Out stock</p> <p>RFQ</p>
 <p>62S11-H9-020S výrobcovia: Grayhill, Inc. popis: ROTARY ENCODER OPTICAL 32PPR Skladom: Out stock</p> <p>RFQ</p>	 <p>62S11-H9-P výrobcovia: Grayhill, Inc. popis: ROTARY ENCODER OPTICAL 32PPR Skladom: Out stock</p> <p>RFQ</p>
 <p>62S11-H9-PH výrobcovia: Grayhill, Inc. popis: ROTARY ENCODER OPTICAL 32PPR Skladom: Out stock</p> <p>RFQ</p>	 <p>62S11-H9-025S výrobcovia: Grayhill, Inc. popis: ROTARY ENCODER OPTICAL 32PPR Skladom: Out stock</p> <p>RFQ</p>
 <p>62S11-H9-060C výrobcovia: Grayhill, Inc. popis: ROTARY ENCODER OPTICAL 32PPR Skladom: Out stock</p> <p>RFQ</p>	 <p>62S11-H9-040C výrobcovia: Grayhill, Inc. popis: ROTARY ENCODER OPTICAL 32PPR Skladom: Out stock</p> <p>RFQ</p>