

LilyPad

SEWABLE ELECTRONICS KIT GUIDE

v1.0



LilyPad Sewable Electronics Kit Guide

v1.0



INTRODUCTION

1 INTRODUCTION

6 LILYPAD BASICS



18 PROJECT 1: GLOWING PIN



28 PROJECT 2: ILLUMINATED MASK



38 PROJECT 3: LIGHT-UP PLUSH



54 PROJECT 4: NIGHT-LIGHT PENNANT

70 TROUBLESHOOTING

72 GLOSSARY

LilyPad Sewable Electronics Kit Guide

v1.0

Copyright © 2016 by SparkFun Electronics, Inc. Some rights reserved.
The LilyPad Sewable Electronics Kit's features, specifications, system requirements, and availability are subject to change without notice.



This work is licensed under the Creative Commons Attribution-ShareAlike 4.0 International License. To view a copy of this license, visit <http://creativecommons.org/licenses/by-sa/4.0/> or send a letter to Creative Commons, PO Box 1866, Mountain View, CA 94042, USA.

Material in the Troubleshooting section (pages 70–71) is copyright © 2013 by Leah Buechley, Kanjun Qiu, and Sonja de Boer under a Creative Commons Attribution-NonCommercial-ShareAlike License. Some rights reserved.



You are free to Share the work (to copy, distribute, and transmit it) and to Remix the work (to adapt it) under the following conditions: You must attribute the work to Leah Buechley, Kanjun Qiu, and Sonja de Boer (but not in any way that suggests that they endorse you or your use of the work); You may not use this work for commercial purposes; If you alter, transform, or build upon this work, you may distribute the resulting work only under the same or similar license to this one.



Introducing the LilyPad Sewable Electronics Kit

Welcome to the LilyPad Sewable Electronics Kit, designed to help you explore the world of **e-sewing (electronic sewing)*** through a series of introductory activities using the LilyPad system. This kit is for crafters and creatives of all ages, whether you are brand new to electronics or looking for a new way to explore building circuits. The guide begins with an introduction to basic e-sewing techniques and a simple **circuit** project. You then move on to more complicated projects involving multiple circuits (**parallel circuits**), **buttons**, and **switches**. Finally, you'll use the pre-programmed LilyMini to create a project with advanced behaviors limited only by your imagination. At the end of each project chapter are images and variations to spark your creativity. The Troubleshooting section (page 70) helps you identify and solve problems you may encounter with your circuits. By the end of this guide, you will have crafted a glowing pin, an illuminated mask using three **LEDs (Light-Emitting Diodes)**, a plush that lights up using a button and switch, and a pennant that displays a pre-programmed light pattern. Let's get started!

***See Glossary for definitions of terms in this style.**

What Are Sewable Electronics?

Sewable electronics combine traditional craft processes (sewing, fashion design, and textile design) with electrical engineering, computer science, and hardware skills.

With sewable electronics you can create **e-textiles (electronic textiles)**, which are often wearable, flexible projects that look less like traditional electronics and more like craft and art projects. Many e-textile projects replace wiring with flexible conductive materials such as **conductive thread** and fabric. For the projects in this guide, we will be sewing circuits together with conductive thread.

What Is LilyPad?

The LilyPad system is a set of sewable electronic pieces designed to help you build soft, sewable, interactive e-textile projects. Using LilyPad pieces is a great way to

experiment with electronics through the lens of crafting. Each LilyPad piece has large conductive **sew tabs** for easy sewing and a rounded shape so as not to snag fabric or cut thread.

The LilyPad system was designed by Leah Buechley while pursuing her Ph.D. in computer science at the University of Colorado Boulder. The commercial version of the kit, which launched in 2007, was collaboratively designed by Leah and SparkFun Electronics. You can learn more about LilyPad at SparkFun.com/LilyPadSewKit.



LilyPad Creator Leah Buechley



Kit Contents

The **LilyPad Coin Cell Battery Holder** has space for a 20mm coin cell battery and four sew tabs (two positive, two negative). A slide switch turns it on/off.

Used in Projects 1, 2



All the projects in this kit are powered by **3V Coin Cell (CR2032) Batteries**. The top of the battery (marked with a + sign) is positive, and the bottom is negative.

Used in Projects 1, 2, 3, 4

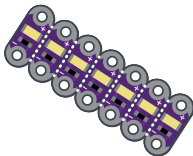

LilyPad LEDs (Light-Emitting Diodes) have two sew tabs (one positive, one negative), marked (+) and (-), which connect to a power source. *LEDs come in a panel and must be snapped apart before using individual LEDs in projects.* The LED's color is labeled on the back of each piece.

Used in Projects 1, 2

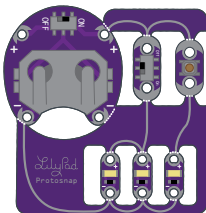

The **LilyPad E-Sewing ProtoSnap** is a set of LilyPad pieces connected together on a single, snappable board, allowing you to explore the circuit's function before you sew it into a project. This ProtoSnap includes a LilyPad Button connected to a LilyPad LED, a LilyPad Slide Switch connected to two LilyPad LEDs, and a LilyPad Coin Cell Battery Holder.

Used in Project 3

INTRODUCTION

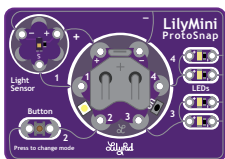

The **LilyMini ProtoSnap** is a pre-wired circuit using a LilyMini, a LilyPad Light Sensor, LilyPad Button, and two pairs of LilyPad LEDs. The LilyMini comes pre-programmed with a set of behaviors.

Used in Project 4



Conductive Thread is a specialty thread made with stainless steel fibers. It can be used instead of copper wiring to connect LilyPad (or other e-textile) pieces together to create circuits.

Used in Projects 1, 2, 3, 4



Needles included with this kit were chosen to fit through LilyPad sew tabs. Two sizes are provided. Choose the one that works best for you.

Used in Projects 1, 2, 3, 4



Templates with circuit diagrams and labels are included for each project in this guide.

Used in Projects 1, 2, 3, 4

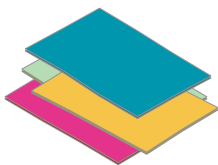

Felt is a great material to start sewing with because it is sturdy and won't fray. Find additional colors and sizes at your local craft store.

Used in Projects 1, 2, 3, 4



Fiberfill Stuffing is included to add some fluff to the plush project.

Used in Project 3

Also Included: Embroidery Thread, Elastic Cord, Pin Back, and Sewing Thread.

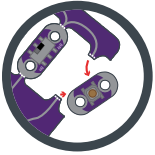

ProtoSnap Components

Some LilyPad pieces come in a ProtoSnap configuration, which means all of the individual components – such as LEDs, battery holder, switches, buttons, etc. – are attached to one another in a single functioning circuit board. ProtoSnap boards are designed to be easily snapped apart into individual pieces when you're ready to begin creating LilyPad projects.



Don't snap apart your ProtoSnap components quite yet. We'll use the unsnapped parts to demonstrate how different types of circuits work.

You Will Also Need

To complete the projects in this kit, you will also need to collect:

- **Scissors**
- **A fabric marker or pen to mark felt or trace templates; for an erasable option, try chalk or disappearing ink**
- **Extra sewing thread for finishing or decorating projects**
- **Hot glue gun (with extra glue) or fabric glue, to help attach LilyPad pieces to fabric before sewing**
- **Extra fabric, printable fabric, and/or craft supplies for decorating your projects**

LILYPAD BASICS

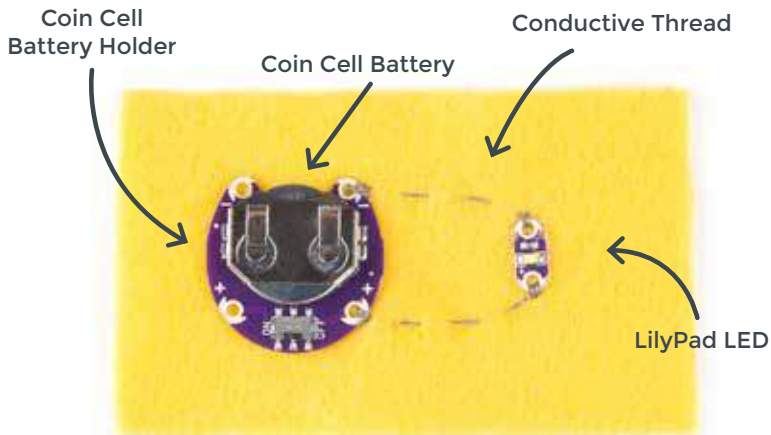

Parts of a LilyPad Circuit

Sewing With Conductive Thread

The projects included in this kit use conductive thread to complete electrical circuits. This section will introduce you to some basic sewing techniques as well as a few special pointers for using conductive thread to build working circuits.

Even if you're already familiar with using a needle and thread, this section may still be useful to you, specifically where it pertains to sewing with LilyPad parts. Throughout the guide you will find icons reminding you to use these techniques.



Securing Your Components

We recommend using a small dot of hot glue (preferred) or fabric glue to attach each LilyPad piece to the fabric to keep it from moving while you sew. Make sure not to accidentally seal up the holes in the sew tabs.



Threading a Needle

Cut a piece of conductive thread approximately 2 feet long. Push one end of the thread through the eye (opening) of the needle and pull through, leaving a tail of about 5 inches.



Tying a Knot

Before you begin sewing your project, you will need to tie a knot at the long end of the thread to prevent you from completely pulling it through the fabric. You can tie a simple overhand or square knot. The next pages will explain a few other knot methods.

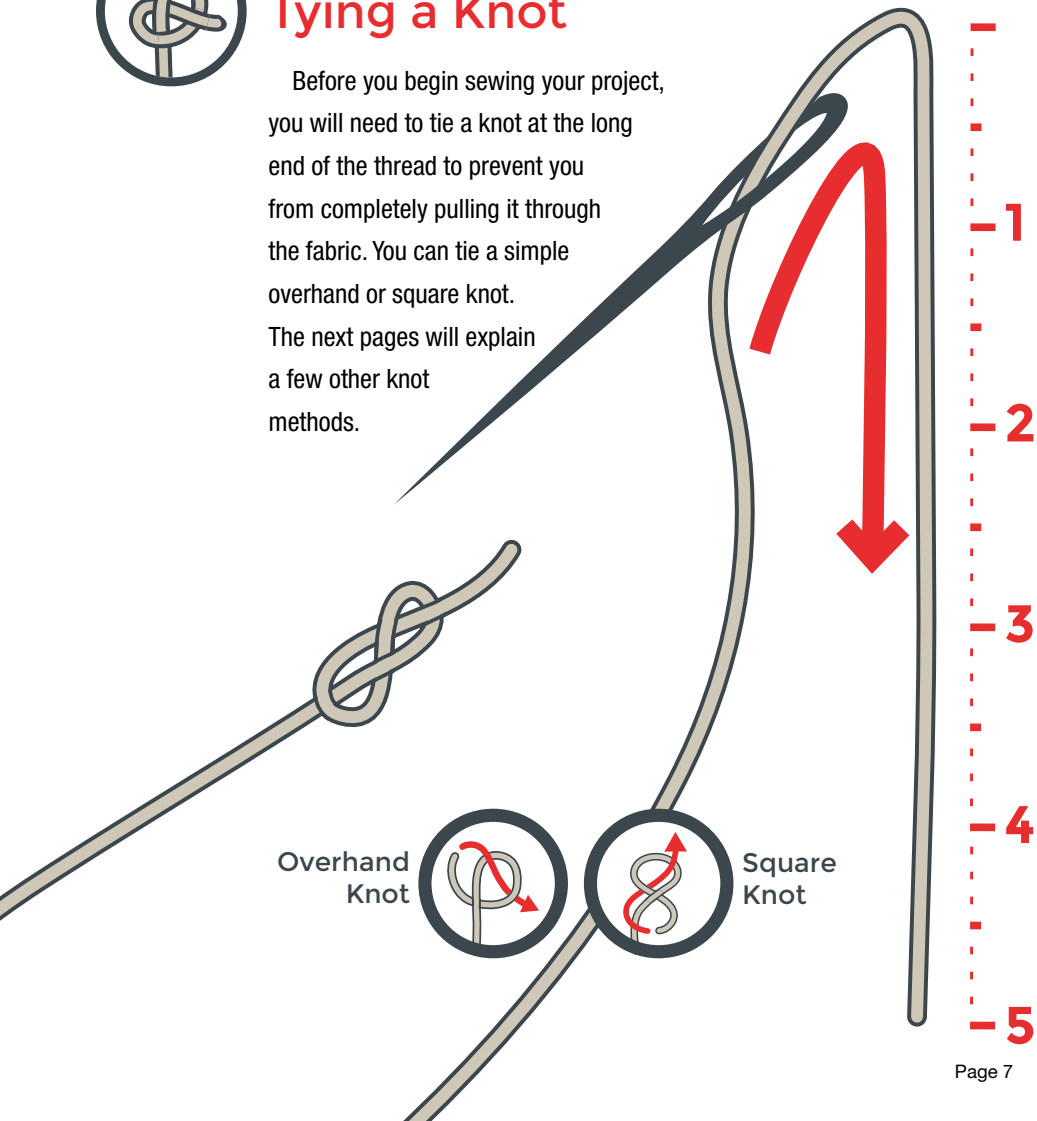

Overhand Knot



Square Knot



The Starter Knot

A starter knot is a method of starting your stitch with a knot directly on your fabric.

1.

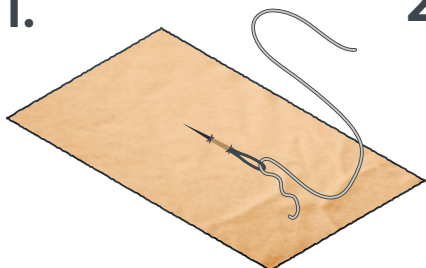

2.

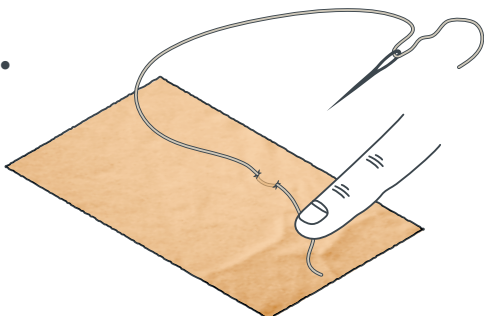

3.

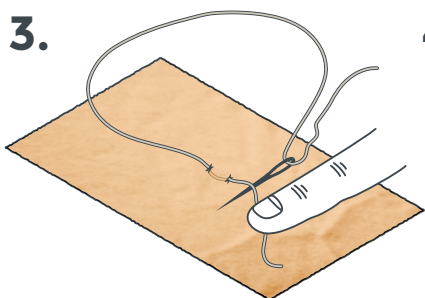

4.

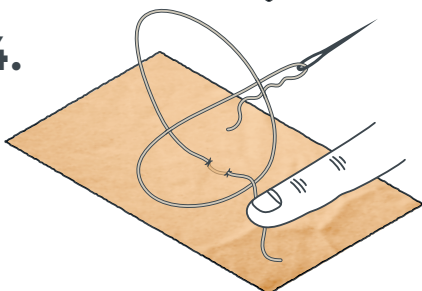

5.

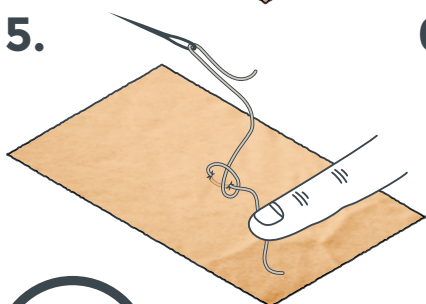

6.

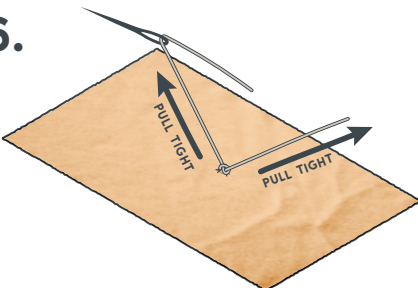

Repeat, making a few more loops through the fabric before trimming the loose tail.



The Quilter's Knot

The slightly more advanced quilter's knot is a way to tie a quick, secure knot on the thread. After some practice, this knot can be tied very quickly.

1.

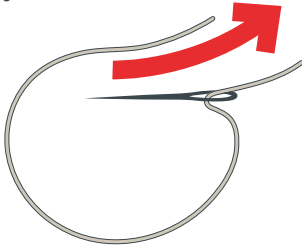

2.

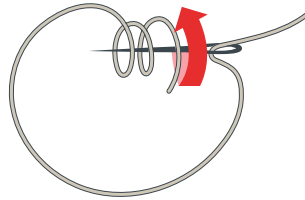

3.

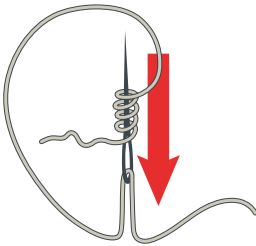

4.

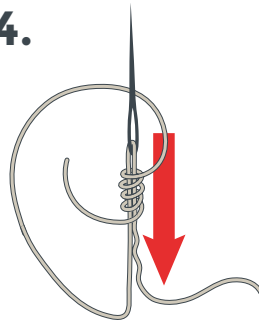

5.



6.

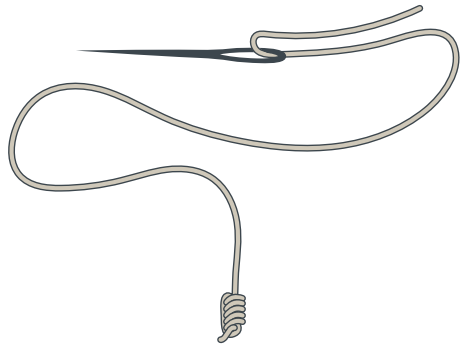



Connecting to LilyPad Sew Tabs

sew tabs x4

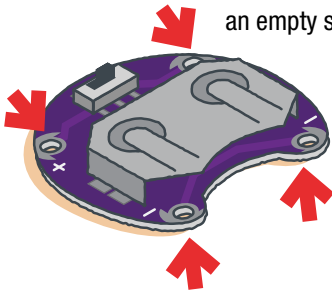

We'll stitch conductive thread around LilyPad sew tabs in our circuits to connect the pieces together. It's important that you make three to four loops each time you connect your thread around an empty sew tab and pull the thread snug with each pass. This ensures you have made a strong electrical and physical connection between the thread and the sew tab. Pull loops tight before continuing your stitch.

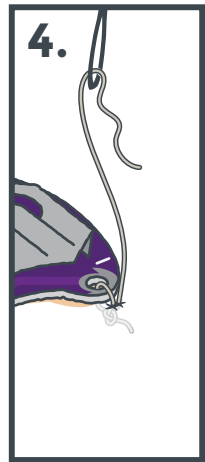
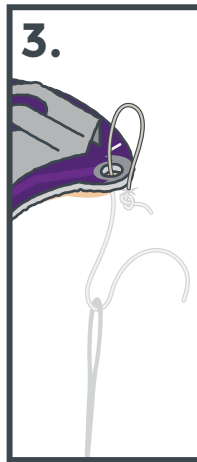
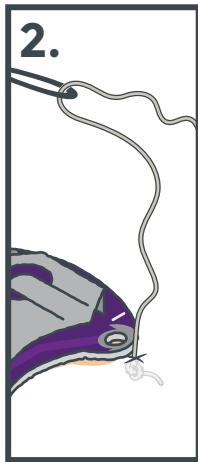

5.

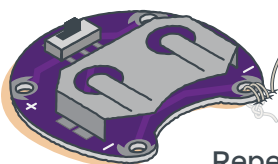

Repeat to make three to four loops.



Don't cut your thread yet. You'll need it to connect the next piece.



Connecting LilyPad Pieces

A running stitch (see page 12) will enable you to connect LilyPad components together with a single length of conductive thread. To connect two LilyPad pieces, stitch three to four loops around the sew tab and continue the stitch.



Multiple LilyPad Pieces

To connect more than two LilyPad pieces, instead of trimming your thread and starting over, continue stitching to the next piece, make three to four loops, and repeat as necessary. There is no need to use a new length of thread if the pieces will share a connection.

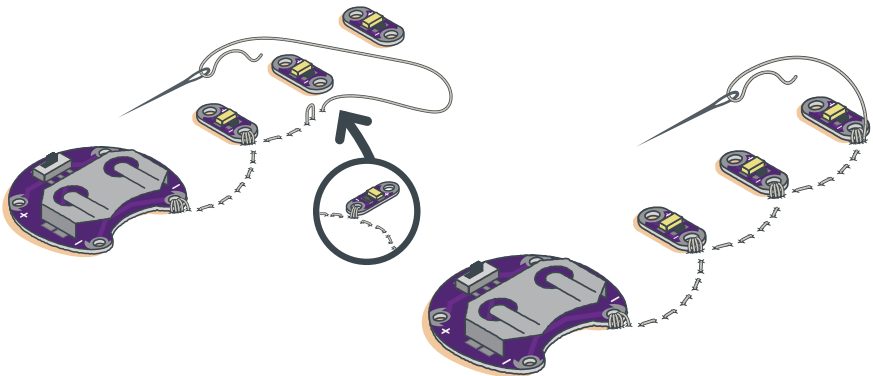

To complete the line of stitching, see page 14 for Finishing Your Connection.



Sewing Basics

After sewing loops around a sew tab, a running stitch will enable you to connect LilyPad pieces together with a continuous length of conductive thread. Follow these steps:

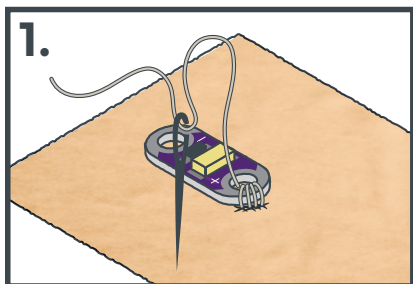

1. Push the needle through the fabric about 1/4" in the direction of your stitch path.

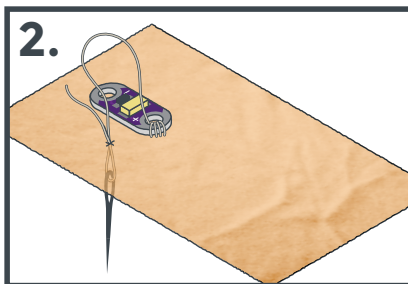

2. Pull the slack of the thread through so it sits flush with the fabric.

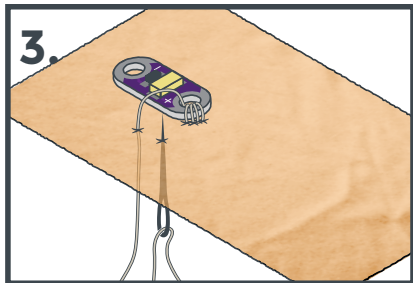

3. Push the needle back up through the fabric another 1/4" along the stitch path.

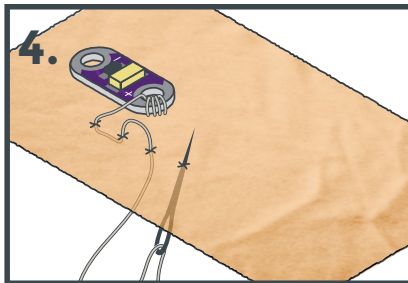

4. Pull the slack of the thread through so it sits flush with the fabric.

Repeat this process to travel along the path to the next LilyPad piece you want to connect to, keeping stitches evenly spaced.

5.

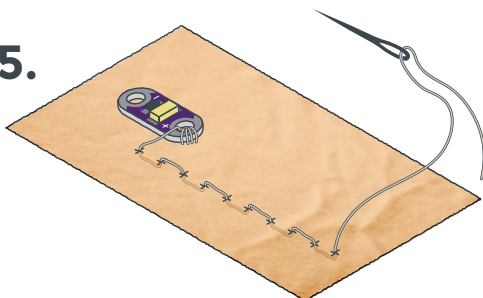



Running vs. Hidden Stitch

In a basic running stitch, the stitching will be even on both sides of the fabric.

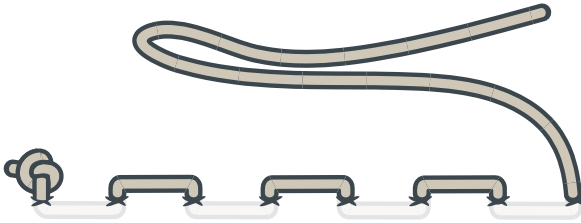

To hide the stitches so that they are not seen on the outside of the project, make a longer stitch on the back of the project and a very small stitch on the front of the project. This method is called a “hidden stitch.”

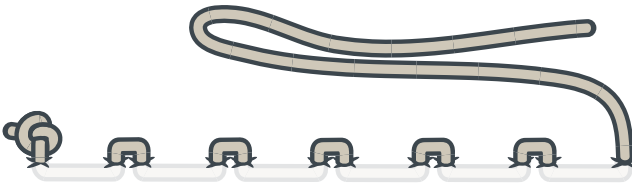

Tip:

As you sew, flip your fabric over every so often to make sure the conductive thread isn't getting knotted or tangled. If you are just starting out with sewing, your stitching may take some practice before it feels comfortable or easy. Remember to be patient with yourself and take your time while stitching. If your thread breaks, you can stitch onto existing conductive thread to continue the electrical connection.



Finishing Your Connection

When you have completed connecting components, use a finishing knot. Thread tails can cause electrical shorts, so be sure to trim your thread afterward.

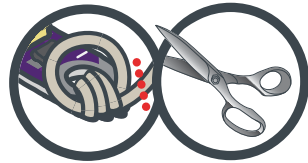
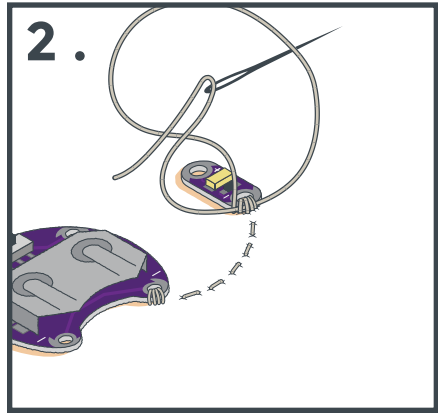
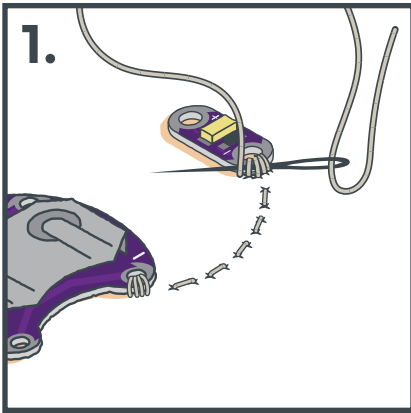

Finishing Knot

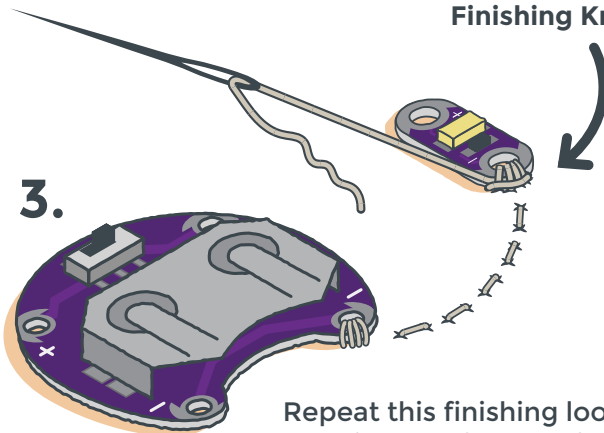

Repeat this finishing loop two times before cutting.

Checking for Conductive Thread Short Circuits

Watch out for any loose threads or knot tails in your project. If any piece of the conductive thread from the **positive (+)** side of your circuit accidentally touches the **negative (-)** side, it can cause a **short circuit**. A short circuit connects the battery to itself and bypasses the rest of your project – and will discharge your battery almost immediately. Stitching directly over stitches in another part of the circuit can also cause a short. It's important that your stitches do not cross over each other or touch other parts of the circuit. The batteries used in these projects shouldn't burn or shock you if they short circuit (although they may heat up), but higher voltage projects or power sources could be dangerous.

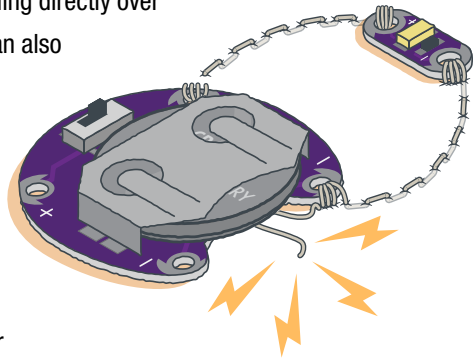

See the Troubleshooting section on page 70 for more information on identifying and correcting short circuits with conductive thread.



First Steps

A green highlight on a step indicates it's the first in a sequence of steps. Make sure to address this step first!



Installing Your Battery

Once all your pieces are connected with conductive thread, your finished circuit needs a power source. Install your coin cell battery, positive (+) side up, into the battery holder.

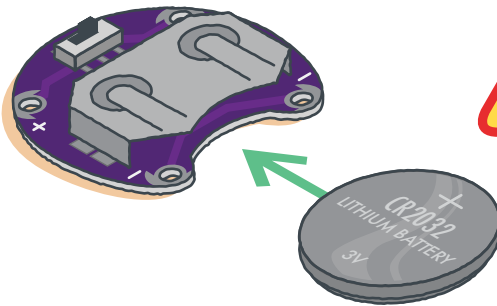

Always remove your battery when working on your circuit to avoid damaging your components.

Testing Your Finished Circuit

Switch your circuit on and see what it can do! If the circuit fails to work, you may have a short, a loose connection, a reversed component, or even something as simple as a dead battery. Check out the Troubleshooting section on page 70.

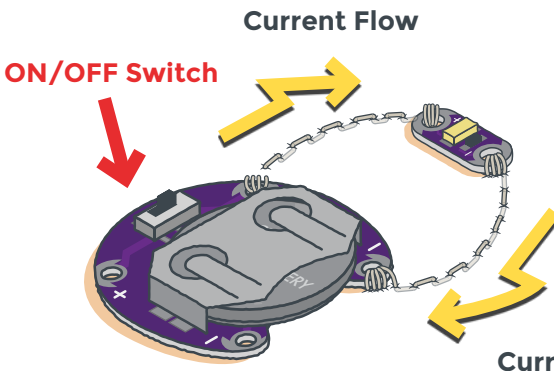

When you turn on the battery holder switch, **current** flows through the conductive thread to the other parts of your circuit. Learn more on page 21.

Caring for Your Project

Unlike copper wire, which has a coating, conductive thread is uninsulated. This means the thread behaves like bare wire and can accidentally short circuit if stray strands come in contact with each other.

To avoid any accidental short circuits after the project is stitched and tested, we recommend covering the thread with a thin layer of fabric glue, fabric paint, or an additional layer of fabric. This is especially important for projects that are wearable or three-dimensional. Never work on a metal surface when using conductive thread.

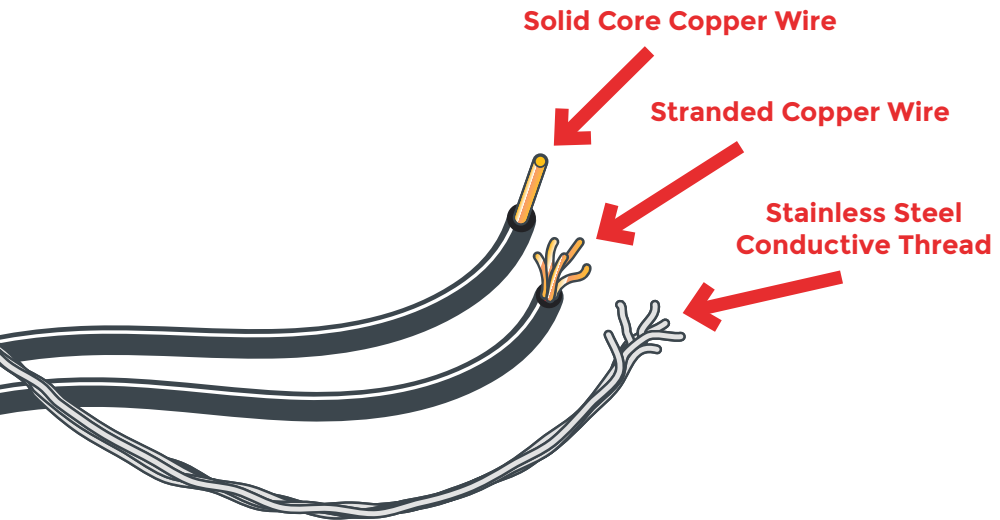

Cleaning Your Project

If your project gets dirty, remove the battery and carefully hand wash with mild detergent. Let your project air dry; a dryer can damage the LilyPad pieces or stitching.

Project 1:

Glowing Pin

🕒 30 minutes – 1 hour



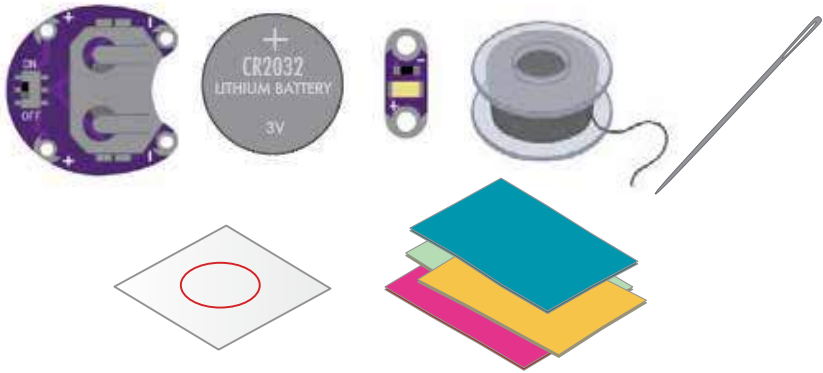

For our first project, we'll create a wearable pin using conductive thread to connect a LilyPad LED to a battery holder. Follow along by drawing your own design on a piece of fabric, or download and print one of SparkFun's designs.



SparkFun has some ready-made design templates, examples, and tips online!

Visit SparkFun.com/LilyPadSewKit

to view and download.

REQUIRED MATERIALS

Included in This Kit:

- Coin Cell Battery Holder
- 3V Coin Cell Battery
- 1 LED (carefully snap out from panel)
- Conductive Thread
- Needle
- Pin Template (1 piece)
- White Felt (you will need at least 3 square inches)
- Pin Back

You Will Also Need:

- Pen, marker, or chalk
- Fabric to draw a design on or printable fabric (optional)
- Scissors
- Hot glue gun (with extra glue)
- Printer if you are downloading and printing one of SparkFun's pin designs



We recommend white felt for this project so that the LED shines through the felt more easily.

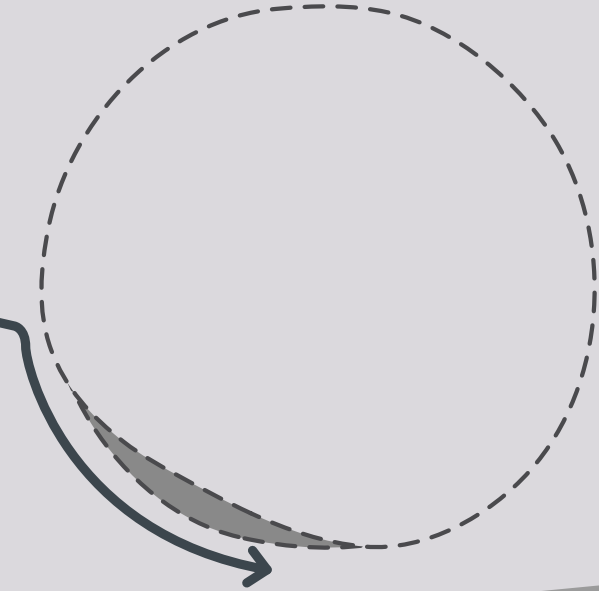

Planning Your Project

Trace the pin template on white felt and cut out. We'll be building our circuit on the felt piece, then adding a decorative layer of fabric with designs on top of it. Trace and cut a slightly larger circle or SparkFun design (see SparkFun.com/LilyPadSewKit) out of thin fabric (or a second piece of felt) for the top layer of the pin.

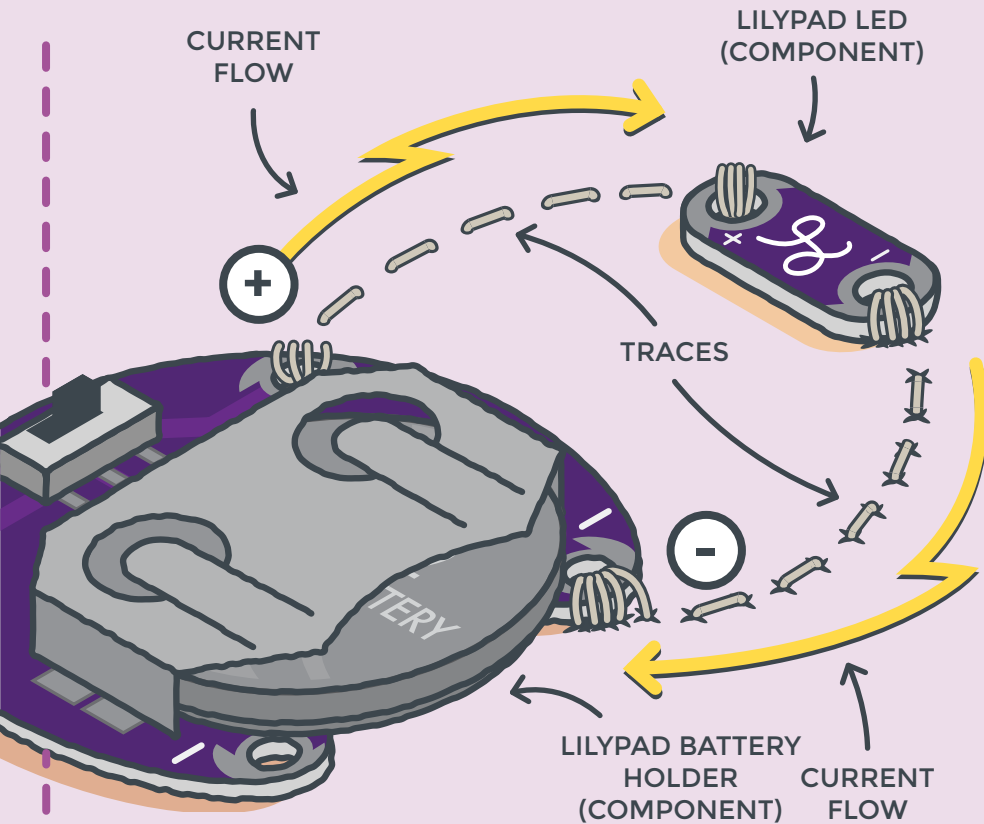

Understanding Your Circuit

This project is an example of a basic circuit – an electrical loop that travels from a power source along a path (called a **trace**) to a component (or components) that uses the electricity to function, and then back to the power source. For our project, we'll use an LED (Light-Emitting Diode). When this loop is completed by stitching the pieces together with conductive thread traces, electricity from the power source is able to flow from the positive (+) side of the battery through to the LED (lighting it up) and back to the negative (-) side of the battery. This electric flow is called current. As you build the projects in this book, you will learn different ways to design conductive thread circuits and experiment with additional pieces that help control or use the flow of electricity. **In this circuit configuration, the LED is facing the fabric to shine through the other side.**

Understanding Your Circuit

Take a look at the LED and battery holder. Notice that the silver sew tabs are labeled either positive or negative. Many electronic components have **polarity**, meaning electric current can only flow through them in one direction.

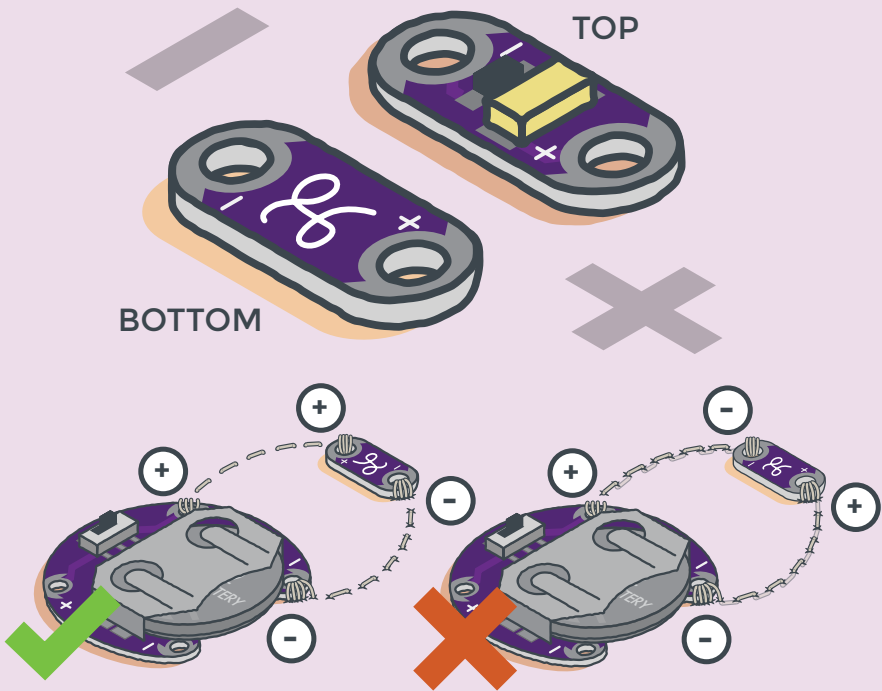

If hooked up incorrectly, they either will not work or will break. The batteries in this kit are also polarized; they have a positive and negative side. Always check the labels on LilyPad pieces to make sure they are correctly oriented before sewing together a circuit. **In this circuit, the LED is installed facing the fabric to shine through the other side. This only happens for Project 1; the rest will have the LED facing away from the fabric.**

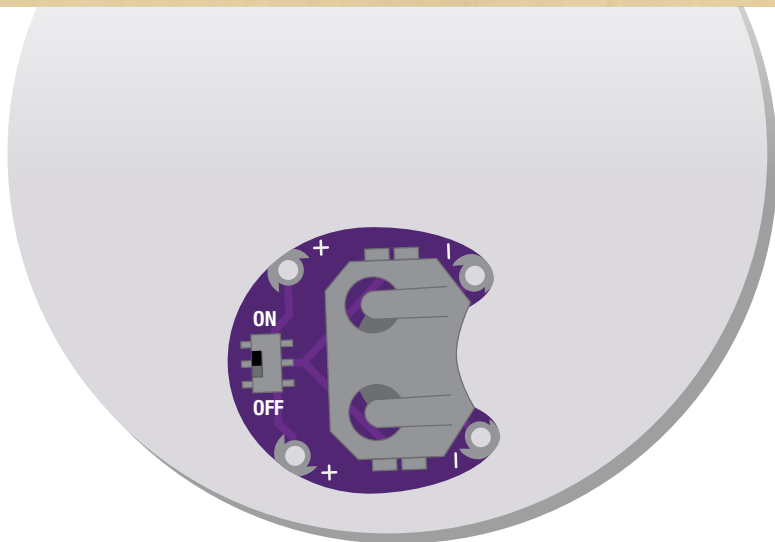

Arranging Your Circuit

Position the battery holder with the ON/OFF switch to the left side and the bottom two sew tabs close to the bottom edge of the felt. Use a small dot of hot glue in the center of the holder to attach it to the felt, as shown. Gluing the battery holder on this way leaves room for placing the LilyPad LED on the felt.

While planning the LED's placement, note that it will need to be slightly above the center or toward the top half of the fabric so it doesn't touch or overlap the battery holder.



Remember: Glue is great for keeping your components in place, but it can interfere with your circuit. **Try to keep glue clear of sew tabs.**

GLOWING PIN

If you are using one of SparkFun's pre-made designs, hold the design over the felt, and use a fabric marker or chalk to mark where the LED should be placed to shine through. Snap one LED off the LED panel.

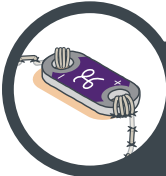

For this project only, we'll place the LED with the lens facing the felt, allowing it to shine through to the other side. The back of the LED has a cursive L, which should be facing you. For the rest of the projects in this book, we'll install the LED with the lens up (away from the felt).

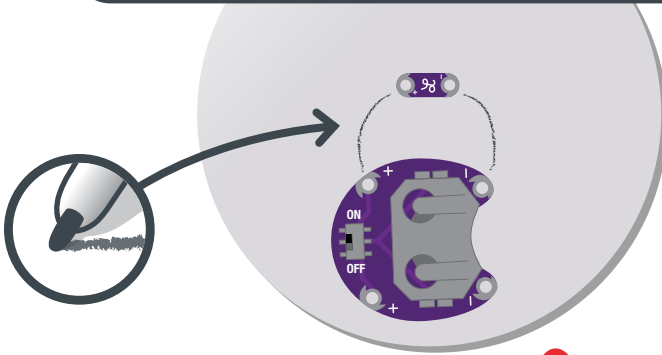

Make sure your battery is not installed in the battery holder.

Before attaching the LED, rotate it so the (+) and (-) symbols on the LED board align with the (+) and (-) symbols on the battery holder's sew tabs. Use a small dab of hot glue on the center of the front of the board to secure to the felt.

Be careful not to cover the holes with glue – we'll need those to sew through later.

Do not put your battery in yet.

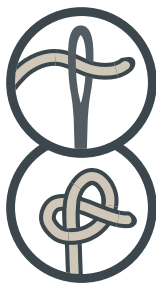

Stitching It Together

1 Cut a long piece of conductive thread, thread the needle, and tie a knot at the end. Now it's time to connect the LED to the battery holder with the conductive thread. One line of stitching will connect the positive (+) side of the battery holder to the positive end of the LED. A second line of stitching will connect the negative (-) sides of the boards and complete the circuit.

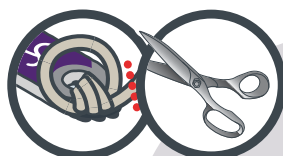
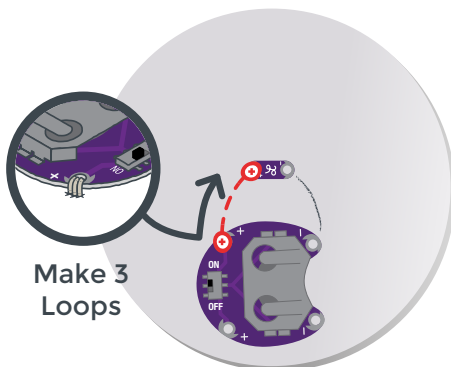

2 Finish your first line of stitching by tying a finishing knot (see page 14) on the sew tab and trimming your excess thread.

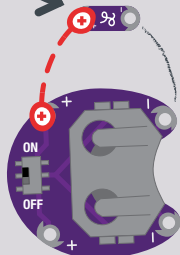

Don't forget!
You'll need to tie a new knot at the end of your thread before you begin the next section of stitching.

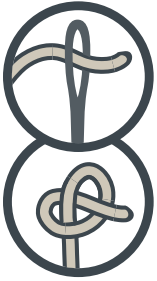

3 Repeat the process with a new piece of thread to connect the negative side of the battery holder to the negative end of the LED. Be careful not to let the stitches touch the path used for the positive connections, as that would cause a short circuit. Trim any thread tails before testing. Now the circuit is complete!

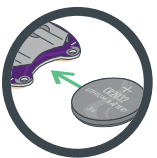
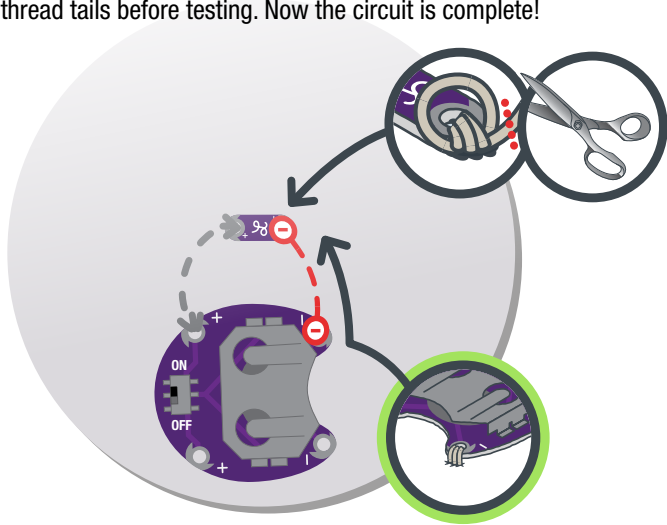

Installing Your Battery and Testing

Insert the coin cell battery with the positive side facing up, labeled as (+), into the opening on the battery holder across from the ON/OFF switch. Turn on the switch to allow current to flow through the circuit. Turn off the switch when not in use to prolong battery life.



Problems? See the Troubleshooting section on page 70 to find a solution.



Always remove your battery when working on your circuit to avoid damaging your components.



Finishing Touches

Remove the battery, and then use a hot glue gun to attach your fabric design over your felt circle so the LED shines through. Draw a design on the fabric if you'd like (or see design templates at SparkFun.com/LilyPadSewKit). Turn the project over and attach an adhesive pin back to finish up your wearable art!



Project 2:

Illuminated Mask

🕒 1–2 hours



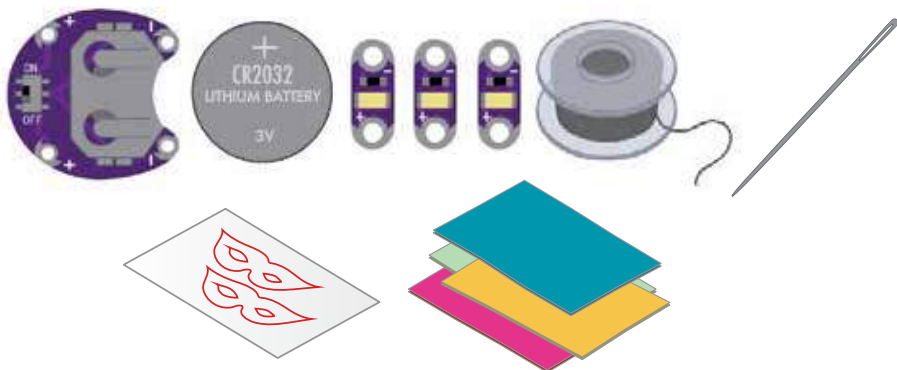

For our next project, we'll be using multiple LEDs in a circuit to create an illuminated mask. This time, instead of stitching just one LED to the battery holder, we'll use a parallel circuit to connect all of the LEDs to the battery.



SparkFun has some ready-made design templates, examples, and tips online!

Visit [SparkFun.com/](https://www.sparkfun.com/)
LilyPadSewKit
to view and download.

REQUIRED MATERIALS

Included in This Kit:

- Coin Cell Battery Holder
- 3V Coin Cell Battery
- 3 LEDs (carefully snap out from panel)
- Conductive Thread
- Needle
- Mask Templates (2 pieces)
- Elastic Cord
- Felt (one 9"x12" sheet of craft felt will make one mask; try mixing colors for a more festive mask)

You Will Also Need:

- Pen, marker, or chalk
- Scissors
- Hot glue gun (with extra glue)
- Optional: Craft supplies for decorating (feathers, sequins, buttons, etc.)



Planning Your Project

For this project we'll be using the mask templates included with your kit. There are two pieces: a top layer and a bottom layer. Hold the top layer template up to your face to check for fit, and make any adjustments to the eye or nose shapes before tracing onto felt.

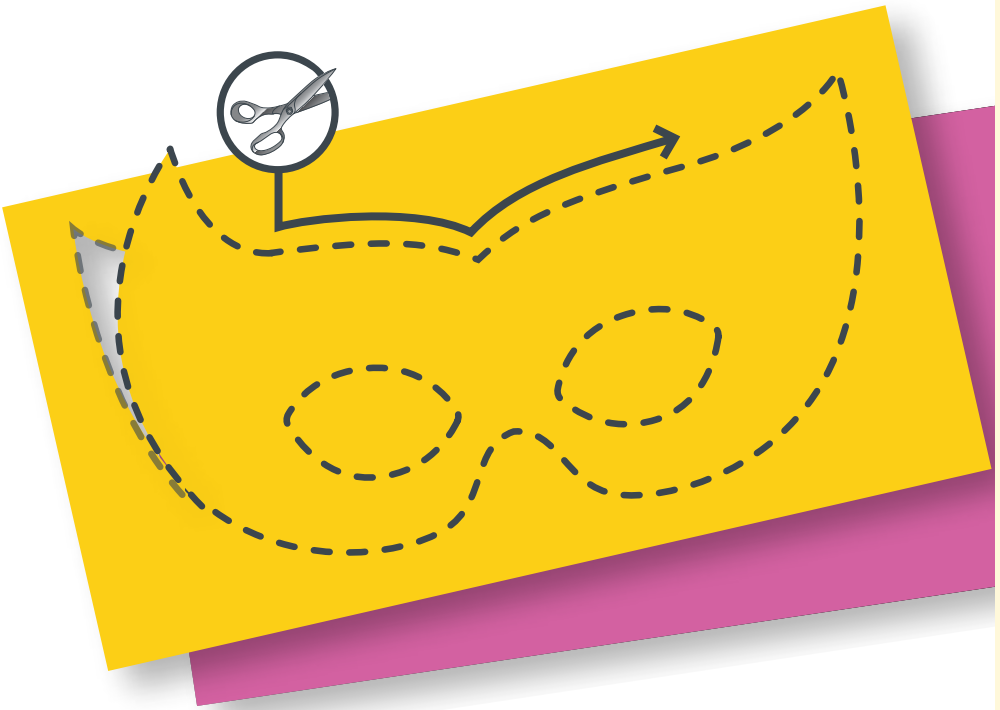

Using a pen or marker, trace the template shapes onto the felt. Both templates will fit on one piece of felt, but feel free to mix and match colors for your design. The electronics will attach to the top layer, while the bottom layer will be used to give the mask extra support. Set aside the bottom layer for now.

Understanding Your Circuit

To light up the mask, we will be connecting the LEDs to the battery holder with a parallel circuit layout. In a parallel circuit, components are connected to get the same amount of power running through them. Each LED in the mask will shine as brightly as the others by sharing a connection to the battery. Most of the e-textiles projects we'll be making will use parallel circuits.

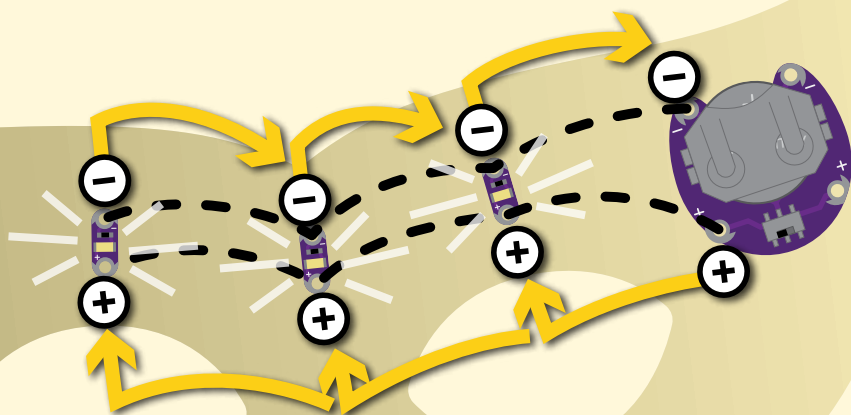



Arranging Your Circuit

Snap three LEDs off of the panel. Use the template as a guide to arrange your components on the felt, securing each piece with a dab of glue on the back to hold it in place. Double check that the (+) ends of the LEDs line up with the (+) tab of the battery holder.



Glue is hard to get a needle through and can interfere with making a strong electrical connection, so try not to get any in the sew tabs.

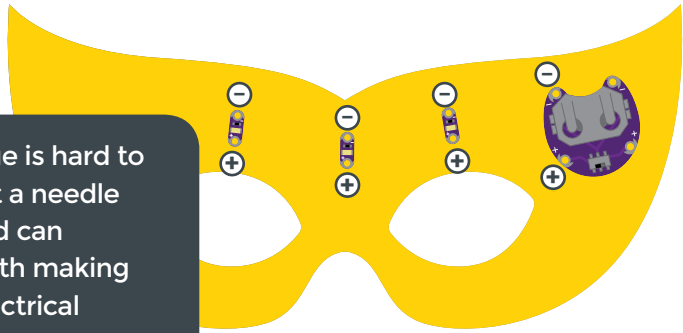

You can use a pen or marker to draw lines from one LilyPad piece to another to provide a path to follow when you stitch. For an erasable option, try disappearing ink pens or chalk.

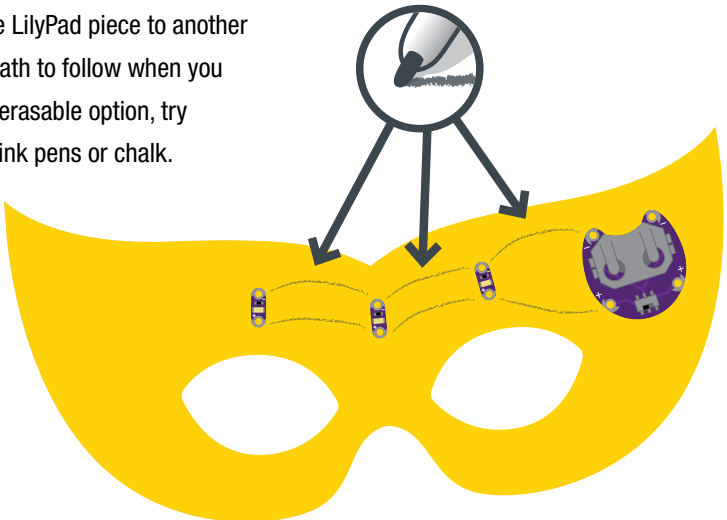

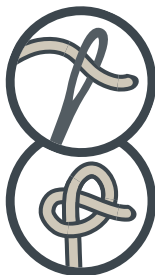

Stitching It Together

1 Cut a long piece of conductive thread, thread the needle, and tie a knot at the end. Sew your first connection: starting from the positive sew tab of the battery holder, connect each of the three LEDs with a running stitch and three loops of conductive thread around each positive (+) sew tab. Tie and cut.

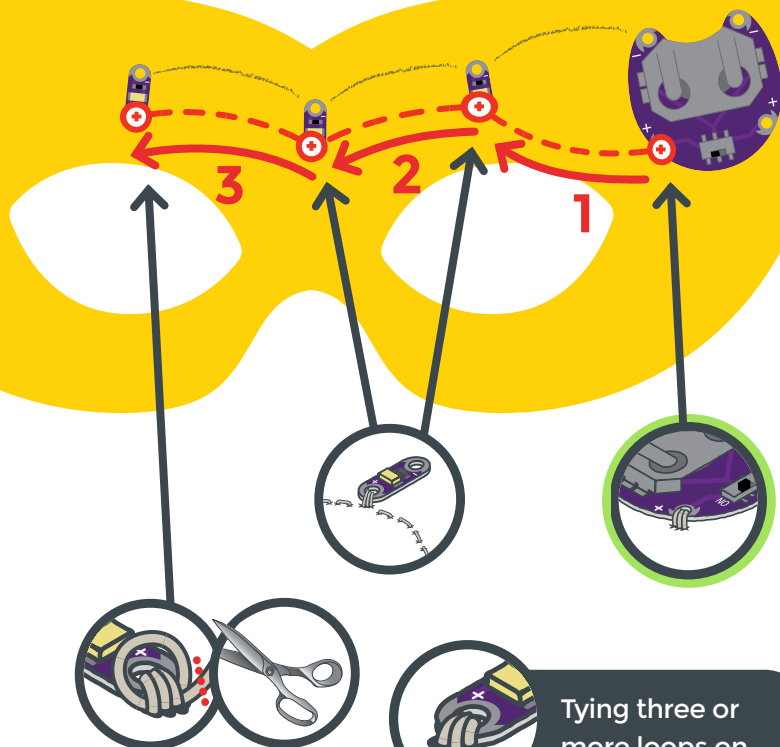

Finish your last line of stitching by tying a finishing knot on the last (+) sew tab and trimming any excess thread. See page 14.

Tying three or more loops on each sew tab is important to ensure you are making a strong electrical connection.

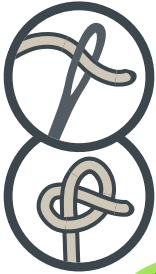

2 With a new piece of thread, repeat the process for the negative side of the circuit – connecting the three LEDs' negative sew tabs to one another and, finally, the negative sew tab on the battery holder. Tie a finishing knot and trim any excess thread.

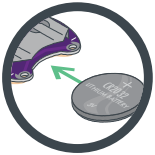
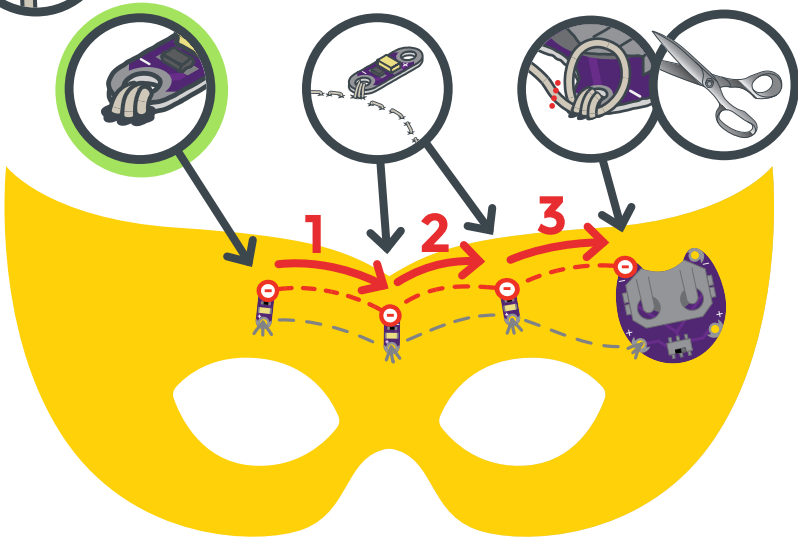

Installing Your Battery and Testing

Insert the coin cell battery into the battery holder with the positive, labeled as (+), side facing up. Slide the switch to ON to see the LEDs light up. Remove the battery, and then continue to the Finishing Touches section.



Problems? See the Troubleshooting section on page 70 to find a solution.



Finishing Touches

After you've checked your circuit, it's time to get creative with adding some details to the mask. With the battery removed, glue the second layer of felt on the back of the mask to add some extra stability and insulate the back of the circuit.



Next, cut small holes on either side of the mask with scissors or a hole punch and tie the elastic to hold the mask on.



Add craft supplies such as glitter, paint, or other decorative accents to enhance or hide your LEDs and stitching. If you want to cover the battery holder on the front of the mask, feathers or big buttons can add pizzazz and hide the board. Make sure you leave an opening so you can replace the battery when necessary.





Project 3:

Light-Up Plush

🕒 2-3 hours



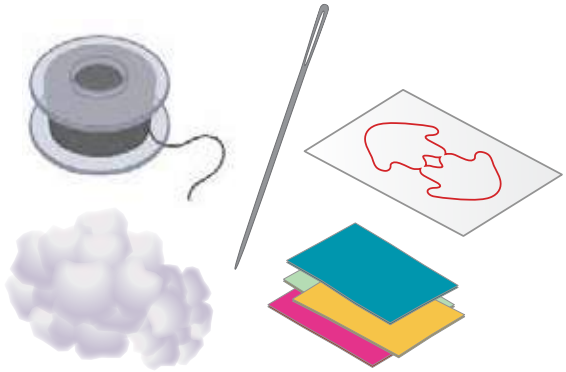
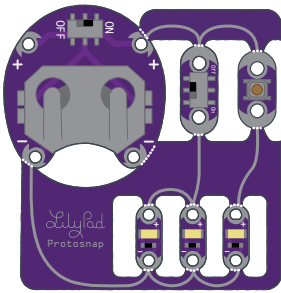

Now that we've experimented with lighting up multiple LEDs at once, let's try individually controlling the LEDs. In this circuit, we'll explore two ways of controlling the flow of current to an LED using a button and switch.



SparkFun has some ready-made design templates, examples, and tips online! Visit SparkFun.com/LilyPadSewKit to view and download.

REQUIRED MATERIALS

Included in This Kit:

- LilyPad E-Sewing ProtoSnap
- Conductive Thread
- Needle
- Plush Template
- Felt (one 9"x12" sheet of craft felt will make one plush; use scraps of felt to add decorations)
- Fiberfill Stuffing
- Embroidery or Sewing Thread

You Will Also Need:

- Pen, marker, or chalk
- Scissors
- Hot glue gun (with extra glue)
- Optional: craft supplies for decorating (feathers, sequins, buttons, etc.)

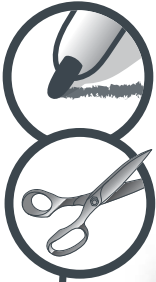

Planning Your Project

Trace and cut out the plush template shape on a piece of felt. To hide your stitches entirely, cut out an extra half-piece of felt (as shown) to place on top of your finished plush (see page 51).



The two halves of what will become your plush are connected at the “feet” to allow your entire circuit to be on one surface and to make stuffing the project easier. **Don’t cut these two halves apart.**

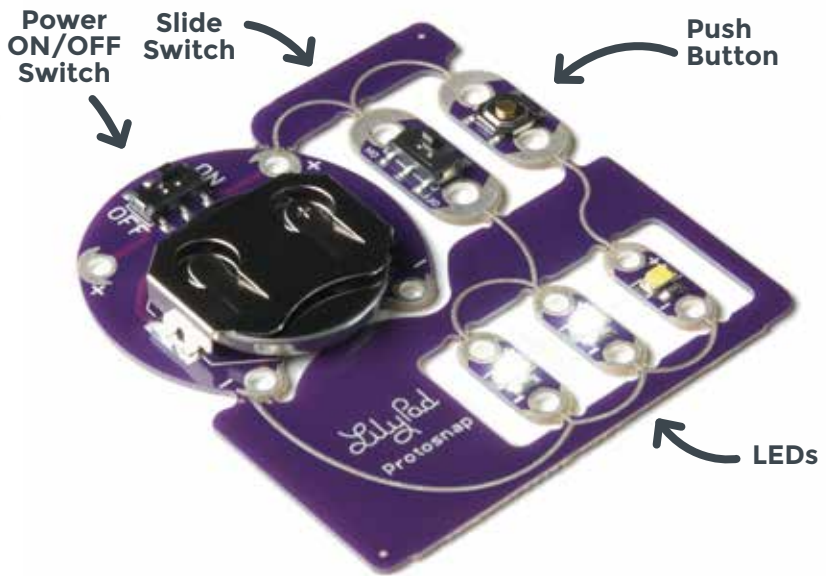

Working With ProtoSnap

We'll use the LilyPad pieces in the circuit to turn different LEDs on and off. Using the E-Sewing ProtoSnap, we'll examine how buttons and switches behave differently, then snap the pieces apart and build them into a plush creature with light-up features.

Before we arrange our circuit on the felt, with the battery installed, slide the battery holder switch to the ON position.

Buttons and switches are electronic components that control the flow of electricity through a circuit. The circuit is closed when current is allowed through by turning on a switch or pressing a button. When a piece of the circuit is disconnected by turning a switch or button off, it is an **open circuit**.



Don't snap apart your E-Sewing ProtoSnap board quite yet. You'll need it intact for a brief experiment first.

Understanding Your Circuit: LilyPad Slide Switch

The LilyPad Slide Switch has a small switch labeled ON/OFF. When the toggle is moved to the ON position, the two sew tabs on the switch are connected, allowing current to flow through and close the circuit. When moved to OFF, parts inside the switch move away from each other and open the circuit (disconnecting it). It helps to visualize switches as drawbridges for electricity – when the bridge is up (open), nothing can cross over. When it is down (closed), the pathway is reconnected, and electricity can flow along the original path.



The ProtoSnap battery holder also has a power switch. The slide switch push button and LEDs won't work until that switch is set to "ON."

Slide Switch
Set to "OFF"



Slide Switch
Set to "ON"

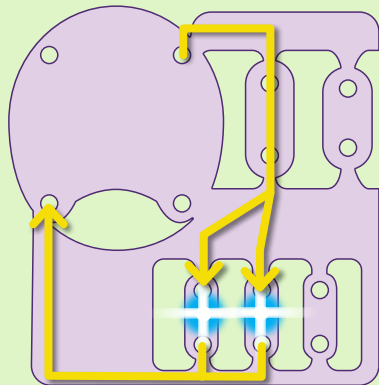
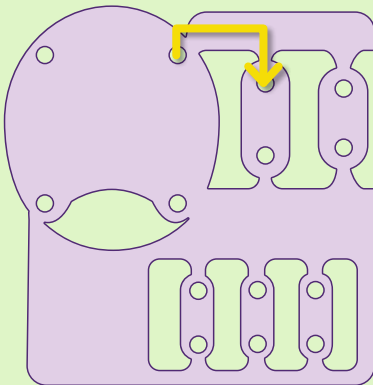
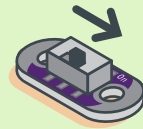

Understanding Your Circuit: LilyPad Button

The LilyPad Button Board is also a type of switch. When you press the button in the middle of the board, it connects the two sew tabs and allows current to flow through. When you let go of the button, the connection is opened again, and the button springs back into place. This button is an example of a *momentary* switch – it is only active when an action is applied. This is slightly different from the slide switch, which is an example of a *maintained* switch, meaning its state remains the same until changed.



Try pressing the button on the ProtoSnap to see how it controls the LED.

Button Not Pressed

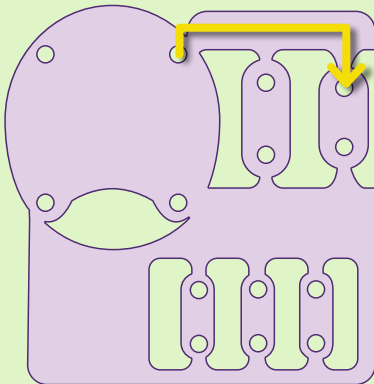

Button Pressed

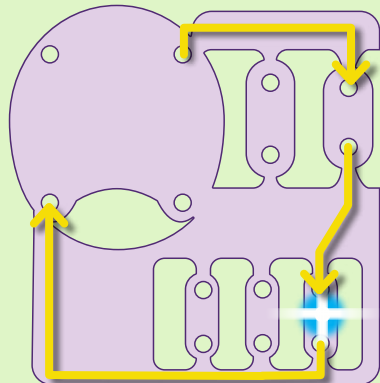

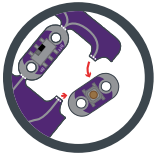

Preparing Your Components

Carefully snap apart the connected components on the E-Sewing ProtoSnap panel. Discard the non-sewable pieces and scraps. You will end up with six LilyPad pieces: a battery holder with battery, three LEDs, a button, and a switch.

Battery Holder

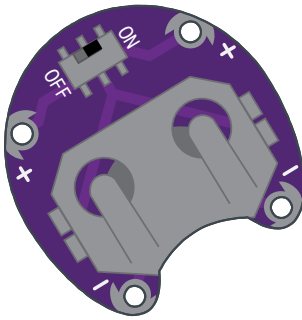

Switch

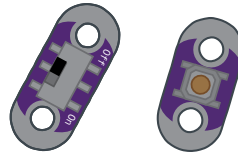

Button

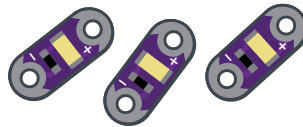
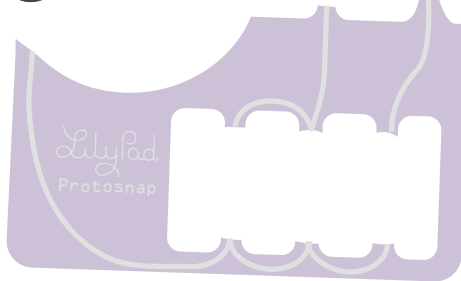

3 LEDs



Always remove your battery when working on your circuit to avoid damaging your components.



Arranging Your Circuit

Arrange the pieces on the felt according to the diagram below. Make sure to check the orientation of the LilyPad LEDs before you stitch them together. The positive tabs of the LED connect to the button or switch, and the negative tabs connect to the negative tab on the battery holder. When your circuit design is finalized, use a dab of glue on the back of each component to attach them to the felt.

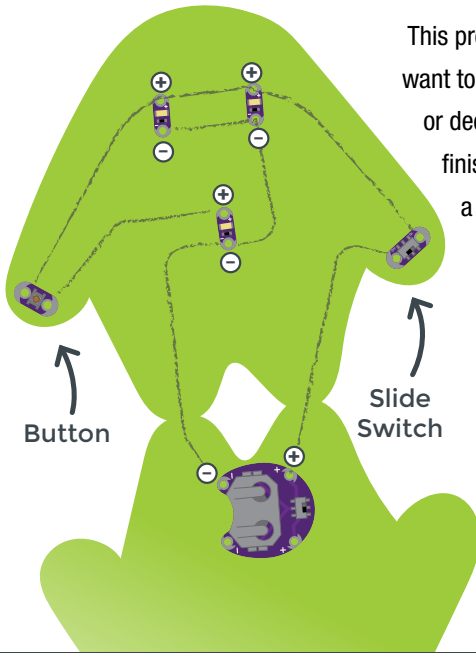

This project has a lot of stitching. If you want to hide the stitches, use a layer of felt or decorations over the thread after you've finished your circuit (see page 51), or use a hidden stitch (see page 13).



For this project, we'll be arranging the pieces slightly differently from on the E-Sewing ProtoSnap. To avoid any crossed conductive thread, we are connecting (+) with both the button and the switch instead of having two separate paths to the battery holder.

When creating circuits with e-textiles, both the electrical properties of the circuit and aesthetic decisions are part of the design process.

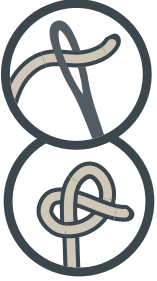

Stitching It Together

1 Cut a long piece of conductive thread, thread the needle, and tie a knot at the end. Begin sewing at the positive sew tab on the battery holder closest to the fold or “feet” on the felt cutout. Remember to use three to four loops around each tab as you sew.

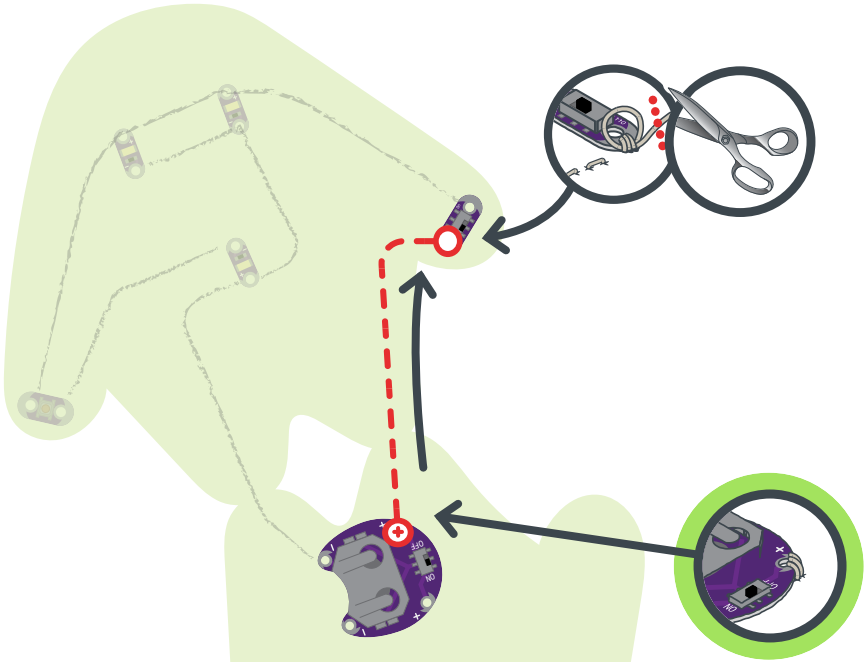

Use a running stitch or hidden stitch (see page 13) to connect the positive sew tab on the battery board to the closest sew tab on the switch. Sew three to four loops around the switch’s sew tab to secure, then tie a knot and cut.

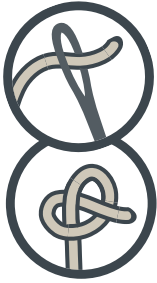

2 With a new piece of thread, connect the other side of the switch to the positive sew tabs of the top two LEDs and end with three to four loops on the closest tab of the button. Tie and cut.

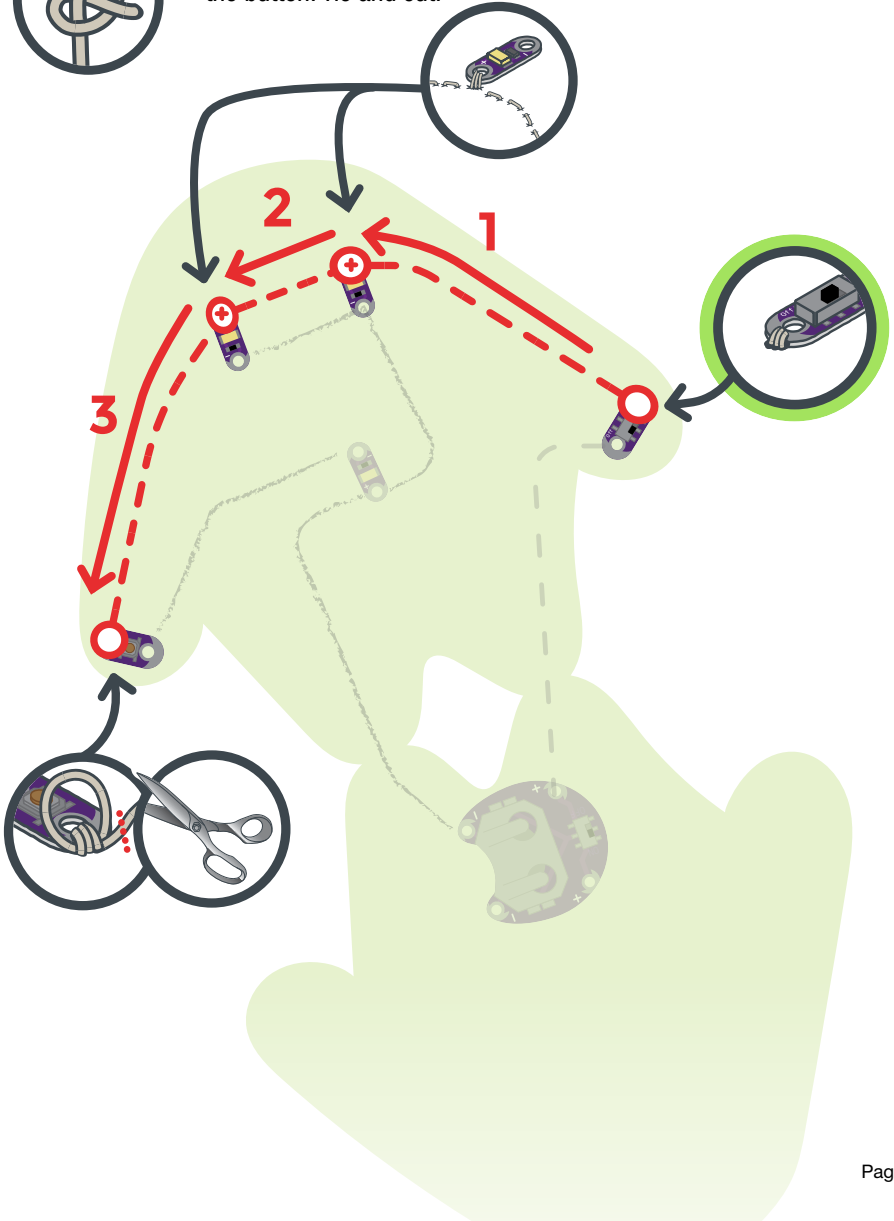

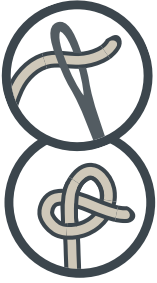

3 With a new piece of thread, begin at the other side of the button and stitch three to four loops around the sew tab. Continue stitching to the positive side of the last LED, ending with three to four loops. Tie and cut.

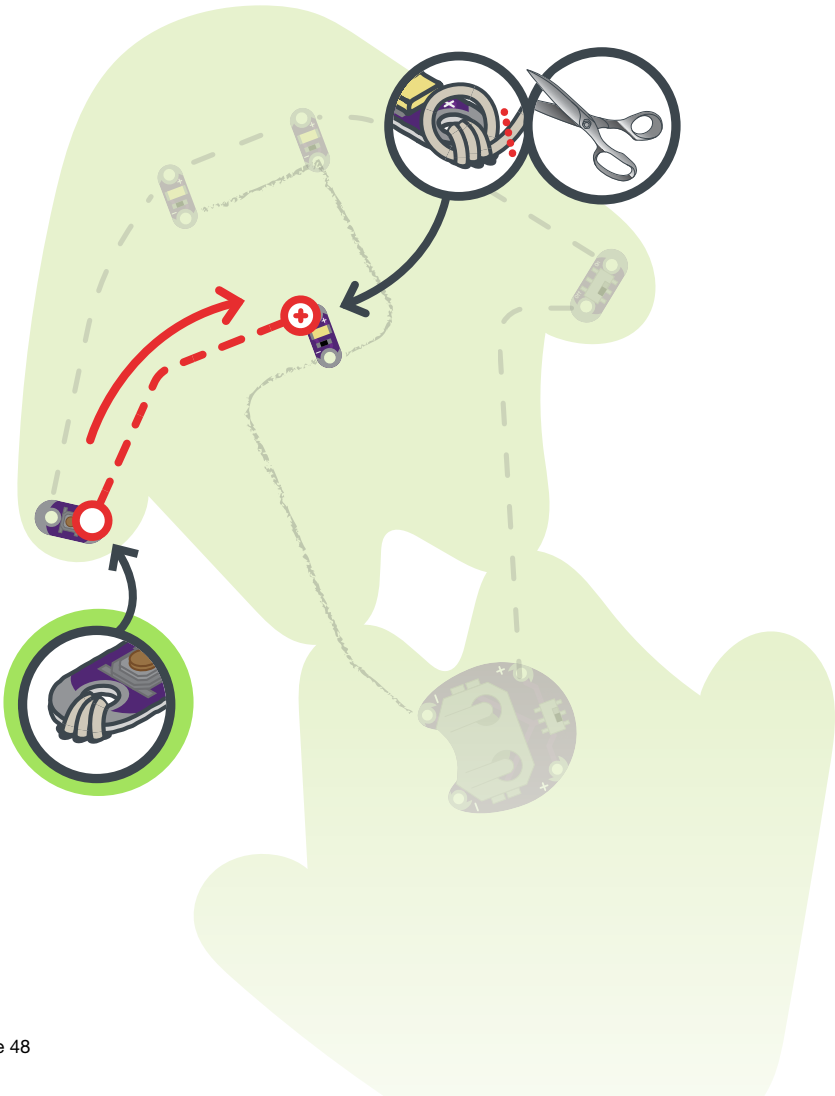

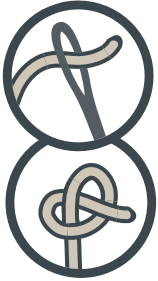

4 Finally, we'll stitch all the negative connections. With a new piece of thread, stitch three to four loops on the negative (-) sew tab of the first LED and connect to the negative tabs on the other LEDs, ending at the negative tab of the battery holder as shown. Make sure to loop three to four times on each connection.



This is a long connection, so make sure to start with at least 2 feet of thread.

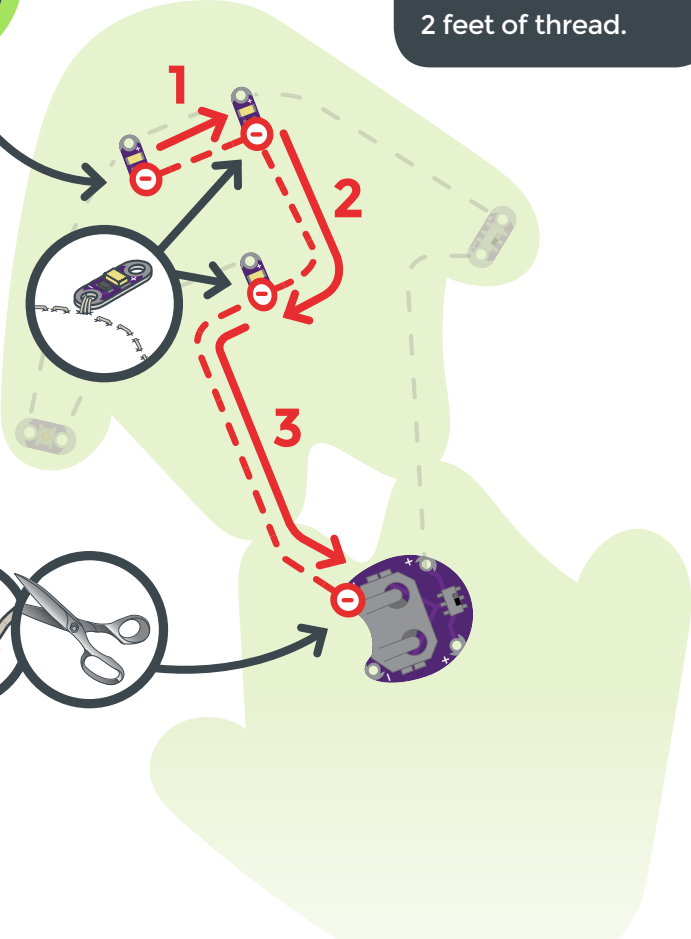
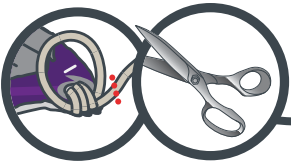
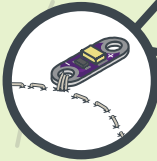

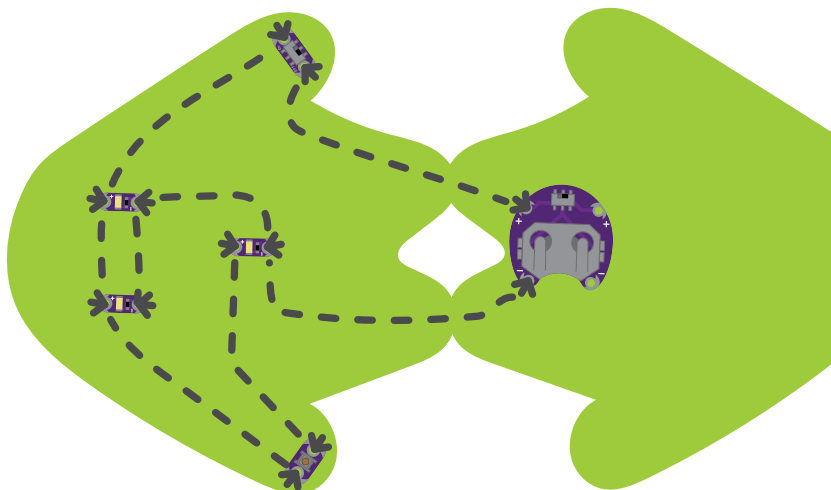

After all the stitching is complete, turn the project over. Trim any loose thread tails before testing.



Installing Your Battery and Testing

Insert the coin cell battery into the battery holder with the positive (labeled +) side facing up. Test the button and switch to make sure the LEDs light up. If they do, remove the battery and continue to the Finishing Touches section.



Problems? See the Troubleshooting section on pag 70 to find a solution.



Hiding Stitches

Conductive thread can be part of the visual design, or hidden. To hide stitches, add a layer of felt on top with cutouts to allow the LEDs to shine through and to access the button and switch.



Always remove your battery when working on your circuit to avoid damaging your components.

Stuffing Your Plush



Once you've finished testing, it's time to make the plush three-dimensional. Remove the battery and fold the felt at the connected points (feet) at the bottom so the LilyPad components are on the outside. Using non-conductive sewing or embroidery thread (or a glue gun) seal all but 2 inches at the top of the plush; we will add fiberfill stuffing in this opening.

Push the fiberfill stuffing into the hole to fill the plush. Use your fingers or a pencil to fill up the arms and legs. The stuffing will give the plush its shape in addition to acting as an insulator for the conductive thread stitching on the inside. Stitch the opening closed with embroidery or sewing thread to finish the project.





Finishing Touches

You can now use craft supplies such as glitter, paint, or other decorative accents to enhance the plush or hide your LEDs and stitching. To protect the battery holder and battery, you can make a small flap of felt to cover the pieces and secure with velcro for easy access.



Project 4:

Night-Light Pennant

🕒 3–4 hours



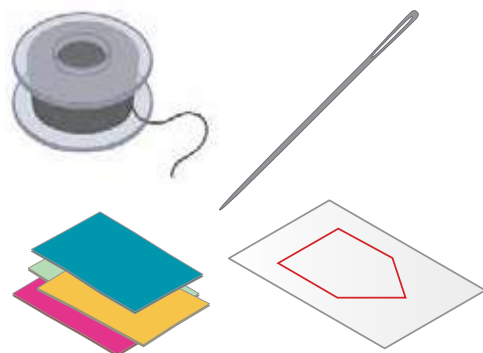
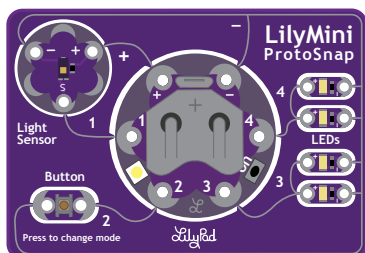

In Project 3, we created a circuit that used a button and switch to light up LEDs; for our final project we'll control LEDs using the LilyMini ProtoSnap. With the code stored on the LilyMini, our projects can now have more advanced behaviors, and interactions are even reprogrammable.



SparkFun has some ready-made design templates, examples, and tips online! Visit SparkFun.com/LilyPadSewKit to view and download.

REQUIRED MATERIALS

Included in This Kit:

- LilyMini ProtoSnap with 3V Coin Cell Battery
- Conductive Thread
- Needle
- Pennant Template (1 piece)
- Felt (one 9"x12" sheet of craft felt will make one pennant; use scraps of felt to add decorations)
- Embroidery or Sewing Thread

You Will Also Need:

- Pen, marker, or chalk
- Scissors
- Hot glue gun (with extra glue)
- Optional: craft supplies for decorating (feathers, sequins, buttons, etc.)



Planning Your Project

Find the pennant template in your kit. Follow along with the circuit diagram on the template or design your own layout and shape on a piece of paper. Trace onto the felt and cut. We'll add the LilyMini and the pieces from the ProtoSnap to a customized pennant to hang on a wall or sew into a project.

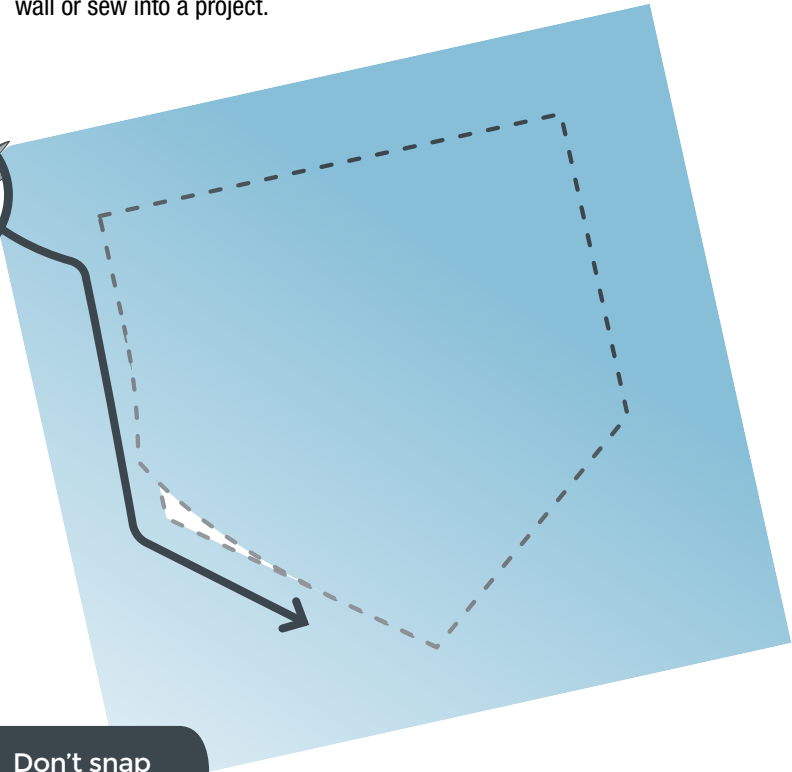

Don't snap apart your E-Sewing ProtoSnap board quite yet. You'll need it intact for a brief experiment first.

Working With ProtoSnap

Like the E-Sewing ProtoSnap, the LilyMini ProtoSnap has all of its pieces wired together, enabling you to test the circuit's function before you sew. The LilyMini board has a small push button to turn it on/off, located between sew tabs 3 and 4. With the battery installed, press and release the button quickly to start up the LilyMini. The LED on the LilyMini (between sew tabs 1 and 2) will turn green when it is on and the battery has a charge, or it will turn red if the battery is getting low, then fade off. To power down the LilyMini, press the button again.

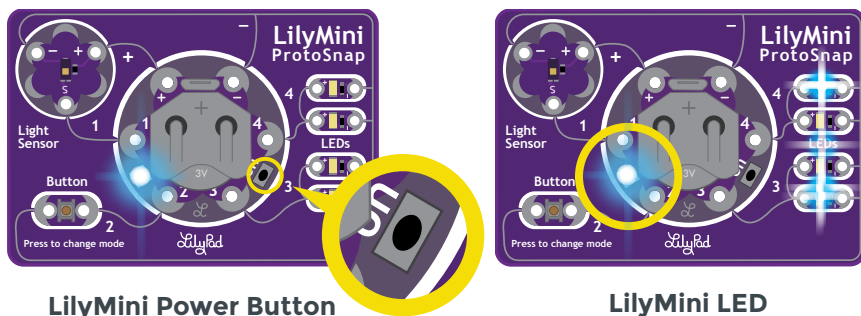

Once powered up, the LEDs on the ProtoSnap should all be on, and the LilyMini's LED will glow white (Mode 1). Press the LilyPad Button to cycle through modes, which use the light sensor to affect the behavior of the LEDs. Use your hand to cover the light sensor and observe what happens to the two pairs of LEDs – when the light level is low, the behavior of the LEDs changes. Press the button again to switch to the next mode.

MODE	COLOR	BEHAVIOR
1	White	All LEDs on
2	Magenta	LEDs fade in and out in a breathing pattern. When the light sensor is covered, LEDs fade faster.
3	Cyan	LEDs off. When the light sensor is covered, LEDs will twinkle.

Understanding Your Circuit: Outputs

The LilyMini is a small computer that can store information and commands to control different sensors and boards connected to it. Programmable boards like the LilyMini are called **microcontrollers**. The LilyMini has been programmed in advance with a set of behaviors, or **code**. See chart on page 57.

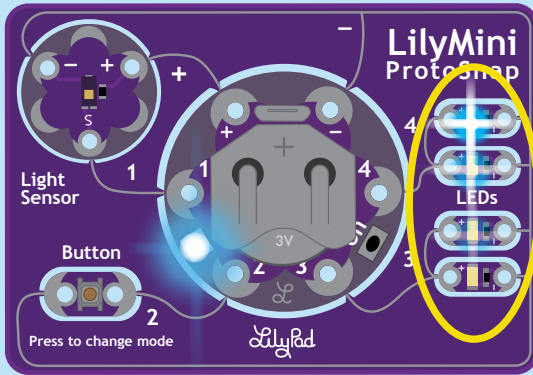

Try It Out!

Press the small button between tabs 3 and 4 to turn your LilyMini on and off. Notice that in this circuit the LEDs behave in a different way. Unlike in our previous circuits, LEDs are not connected directly to the battery. These LEDs are connected to the LilyMini, which uses code to send power to each of its numbered tabs at different times – this is how the light patterns are created. The LEDs are **outputs** – components that receive information from a microcontroller and send it out into the world. Other examples of outputs in circuits are motors, sound creators (such as a buzzer), and displays (e.g., monitors, LCD displays).

Understanding Your Circuit: Inputs

The light sensor and button are **inputs** – components that gather information from the world and relay it to the microcontroller. The LilyMini reads information from the inputs connected to it and makes decisions in the code based on the values it receives. The LilyMini switches modes when the button is pressed. In modes 2 and 3, when the light value from the light sensor falls below a certain level, the LilyMini tells the LEDs to change behavior (breathe or twinkle). When the light level rises again, the LilyMini tells the LEDs to return to the original behavior.

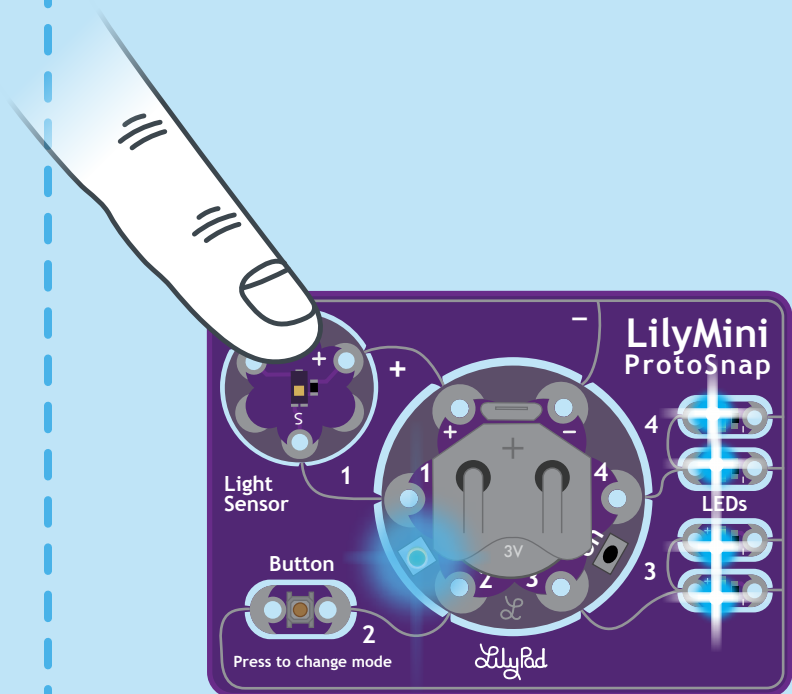

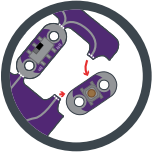

Preparing Your Components

Carefully snap the pieces of the ProtoSnap apart. Use a set of pliers or diagonal cutters if you are having trouble snapping the pieces apart.

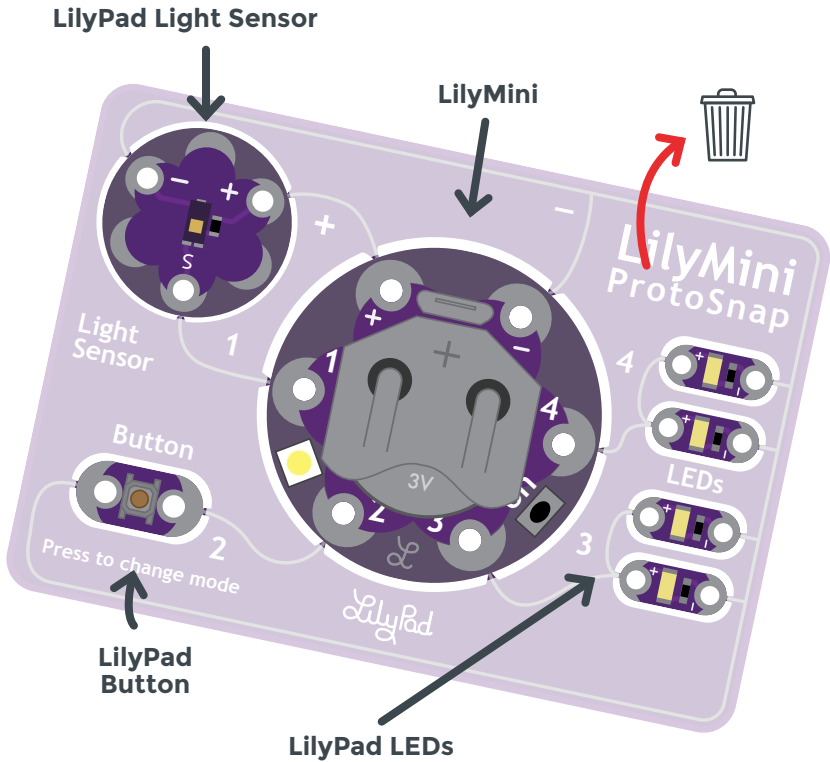

Discard the non-sewable pieces and scraps. You will end up with seven LilyPad pieces: the LilyMini with battery, four LilyPad LEDs, a LilyPad Button Board, and a LilyPad Light Sensor. We will be labeling the LEDs A, B, C, and D in the circuit diagram to help keep track of them while we stitch the circuit. LEDs A and B will be the first pair, and LEDs C and D will be the second pair.



Arranging Your Circuit

Arrange the pieces on the felt according to the diagram (or your own custom design), carefully securing each piece with a dab of glue. Double check the orientation of the LilyPad pieces against the diagram below before gluing.

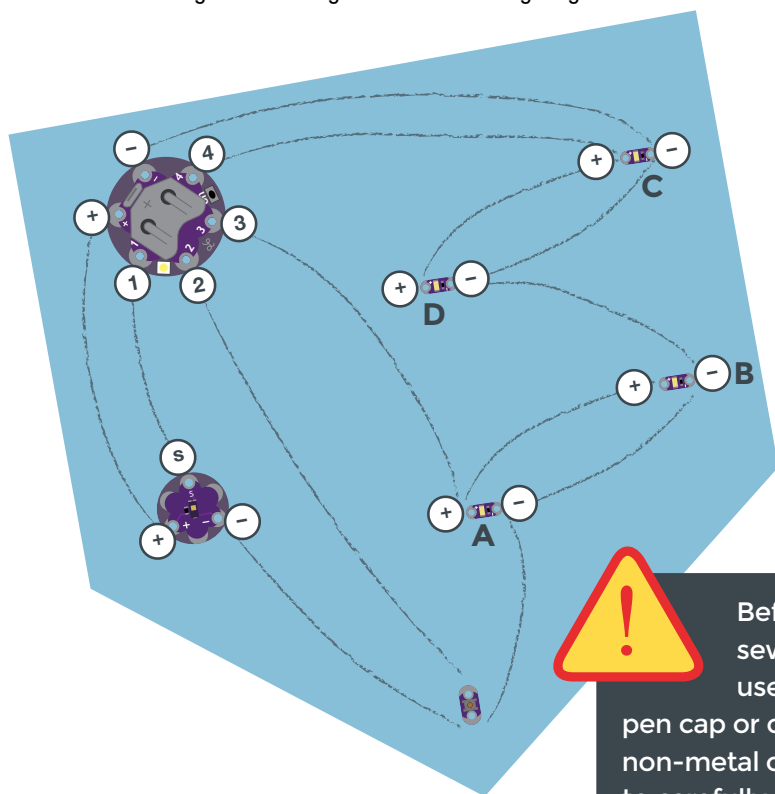

Before sewing, use a

pen cap or other non-metal object to carefully push the battery out of the holder. The LilyMini's battery fits tightly in the holder.



To help you plan your stitch lines, draw your circuit onto the felt with chalk or a washable marker.

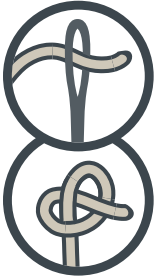

Stitching It Together

1 We'll begin by stitching a connection between the LilyMini and the LilyPad Light Sensor. The light sensor board has three connections: sensor (S), positive (+), and negative (-). Use conductive thread to connect Tab 1 on the LilyMini to the (S) tab on the light sensor with three loops at each tab. Don't worry about connecting the + and - tabs; we'll do that later. Tie and cut.

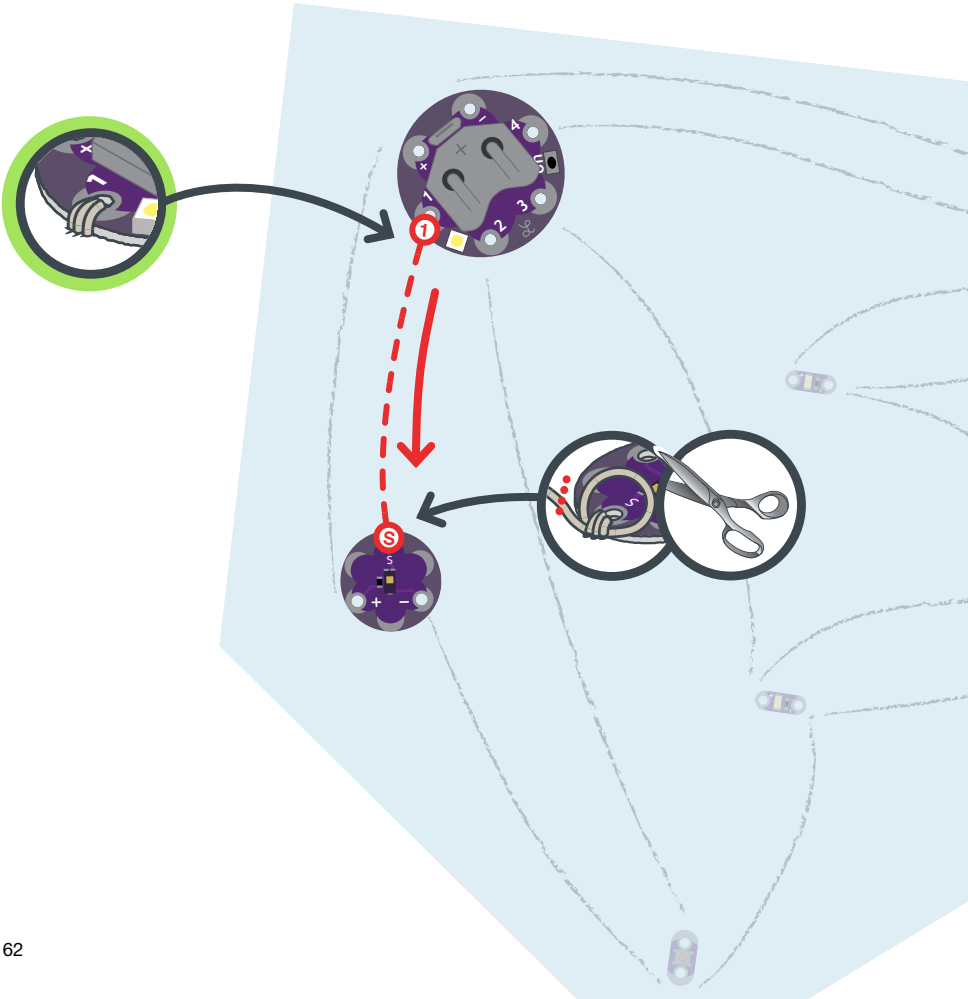

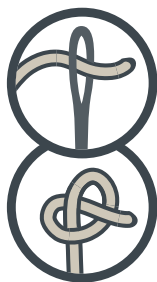

2 Next we'll connect the LilyMini to the LilyPad Button. With a new piece of thread, sew three to four loops around Tab 2 of the LilyMini, and then continue stitching to connect the closest side of the button. Tie and cut.

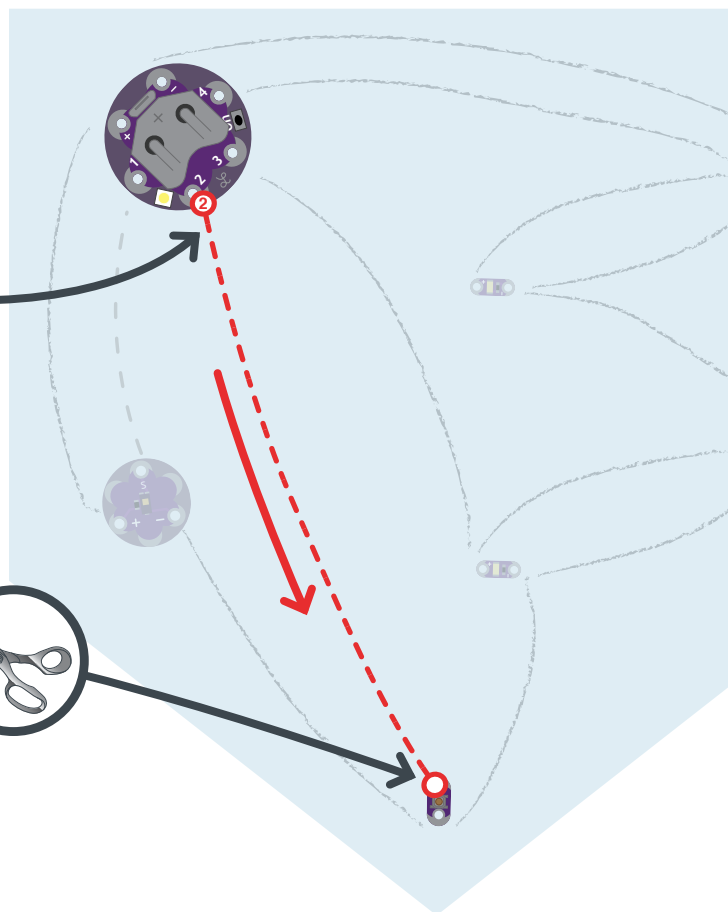
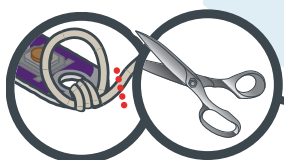

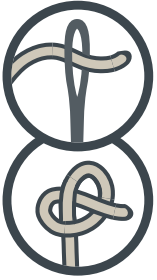

3 Tab 3 on the LilyMini will connect to two LEDs: A and B. With a new piece of thread, connect Tab 3 to the positive (+) of LED A. Continue stitching to connect (+) of LED B, making three loops at each tab. Tie and cut.

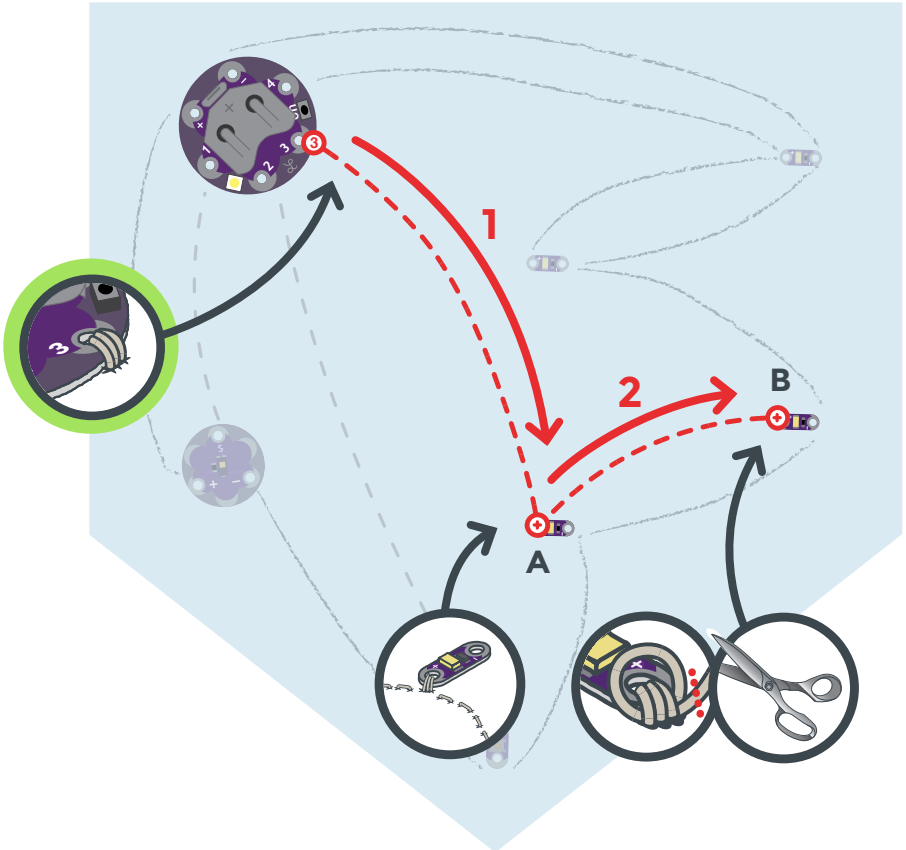

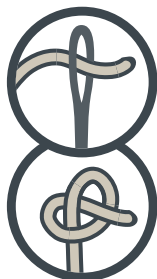

4 We'll repeat this process with a new piece of thread to connect Tab 4 on the LilyMini to the positive tabs of LEDs C and D. Tie and cut.

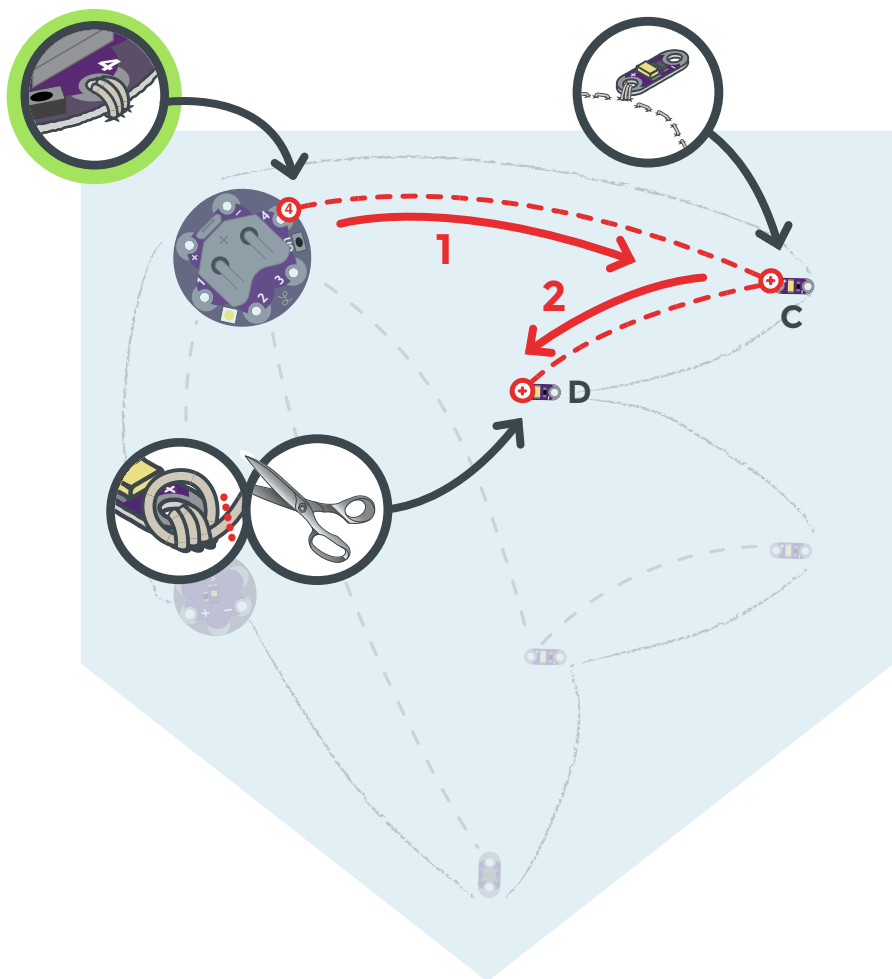

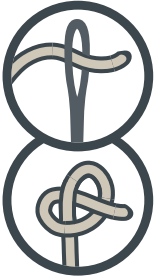

- 5** With a new piece of thread, stitch the positive tab of the LilyMini to the positive tab (+) of the light sensor using three to four loops on each tab and a running stitch between. Tie and cut.

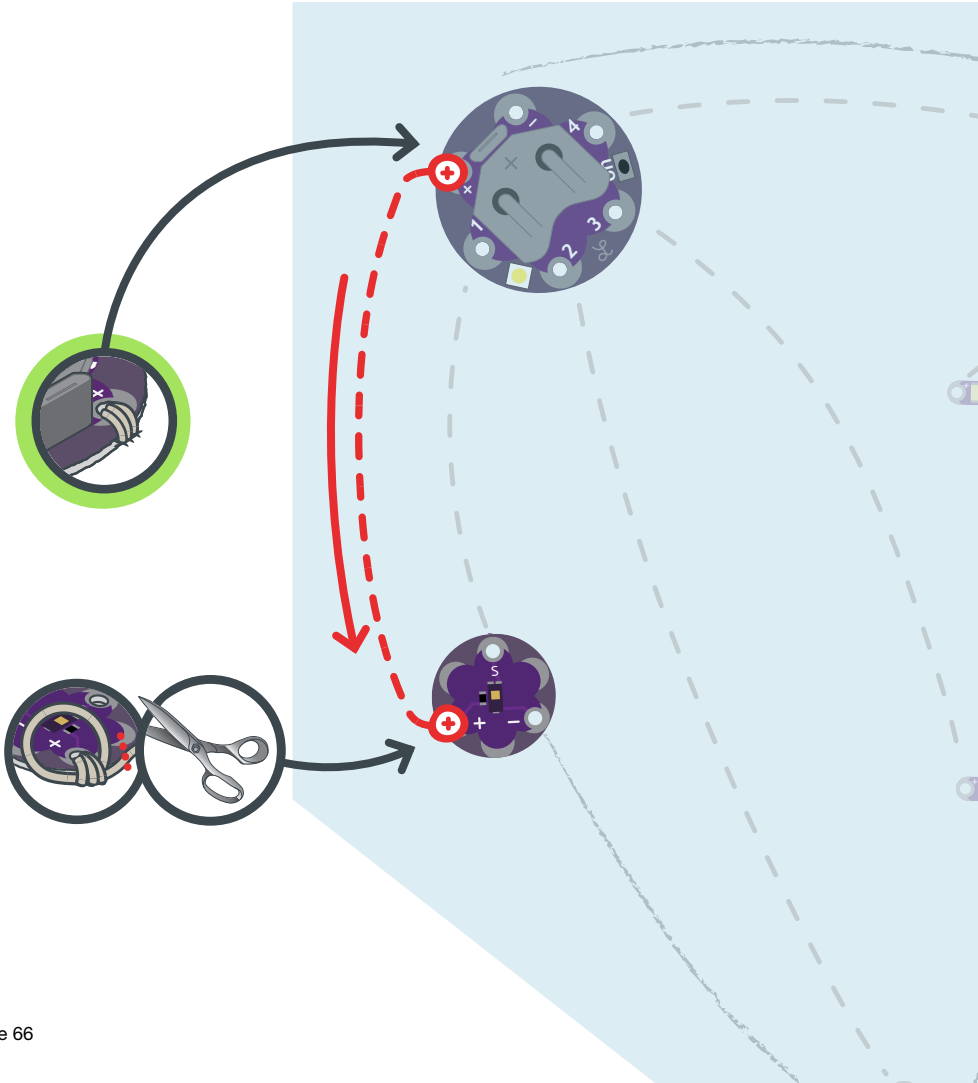

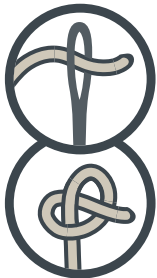

6 Finally, we'll stitch all the negative connections together and back to the negative tab on the LilyMini. **This will require a much longer piece of thread than in other steps – about 2.5 feet.**

Begin at the negative (-) sew tab on the light sensor and continue stitching along the outside edge of the project, connecting to the button as shown and then to the negative tab of each piece (LEDs A, B, D, and C). End at the negative (-) tab of the LilyMini. Tie and cut.

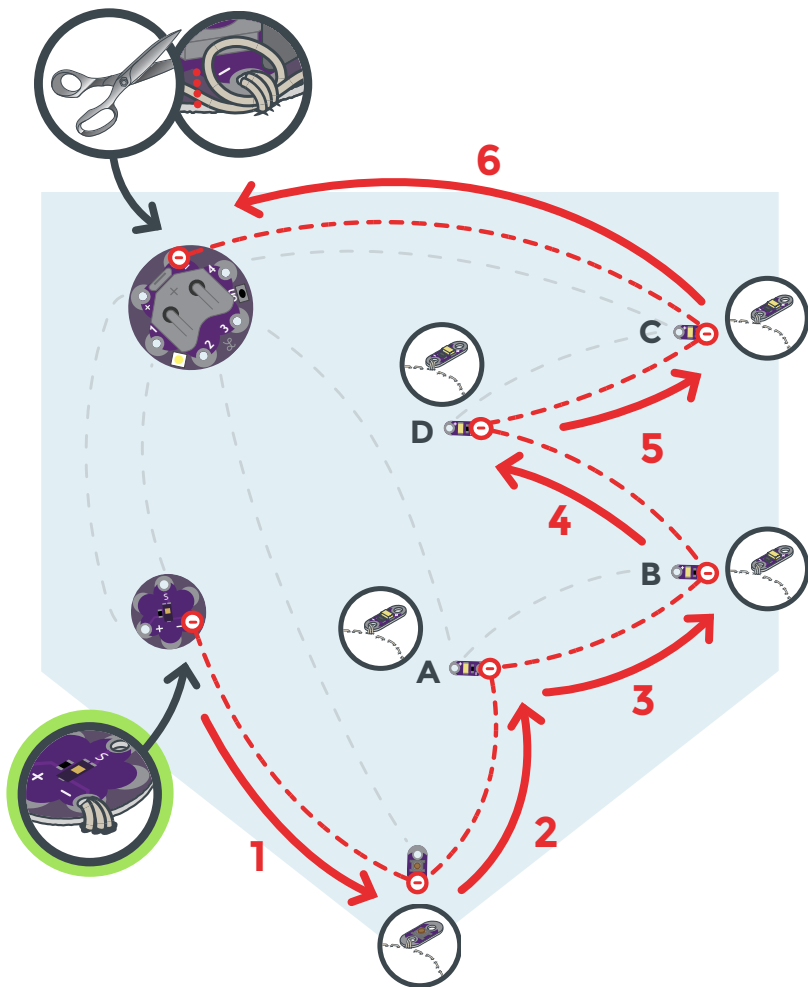



After all the stitching is complete, turn the project over. Trim any loose thread tails before testing.

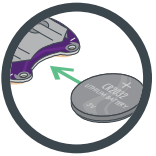
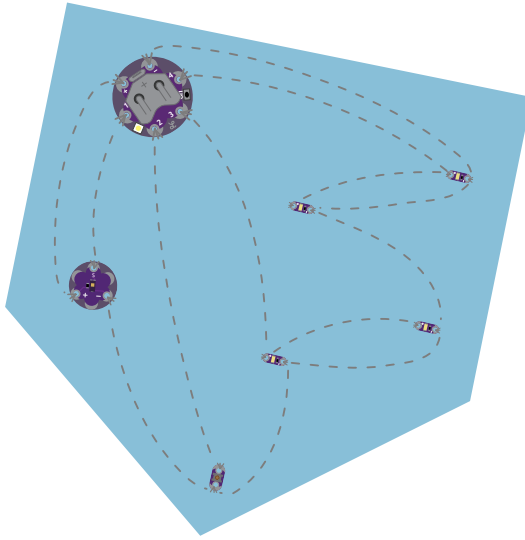

Installing Your Battery and Testing

Insert the coin cell battery into the LilyMini's battery holder with the positive (+) side facing up. Press the power button on the LilyMini; all four LEDs should light up (Mode 1). Press the LilyPad button to switch between modes. Cover the light sensor in each mode to check if the LEDs are changing when the light level changes. If so, remove the battery and continue to the Finishing Touches section.



Problems? See the Troubleshooting section on page 70 to find a solution.



Finishing Touches

After checking the function of the circuit, it's time to customize your pennant. Adding light-colored felt over the LEDs can hide the boards and diffuse the light. If covering the light sensor with a felt decoration, make sure to cut a hole above the sensor so it is not blocked/covered.

Always remove your battery when working on your circuit to avoid damaging your components.



For more information on the LilyMini, including instructions on reprogramming its behaviors, visit SparkFun.com/LilyMini.

TROUBLESHOOTING

LilyPad Battery Holder and LEDs

LED DOESN'T TURN ON

LED ONLY WORKS SOMETIMES

LED IS VERY DIM

CHECK ON/OFF SWITCH

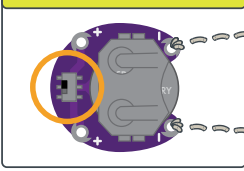

CHECK FOR LOOSE CONNECTIONS

LOOSE LOOPS

UNRAVELLED KNOTS

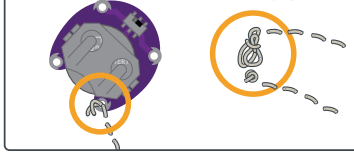

CHECK FOR SHORT CIRCUITS

KNOT TAIL IS TOUCHING

OVERLAPPING STITCHES

THREAD IS TOUCHING ANOTHER PART OF BOARD

STITCHING ACROSS A COMPONENT

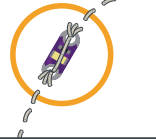
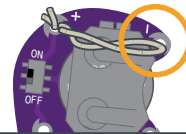

CHECK FOR REVERSED POLARITY

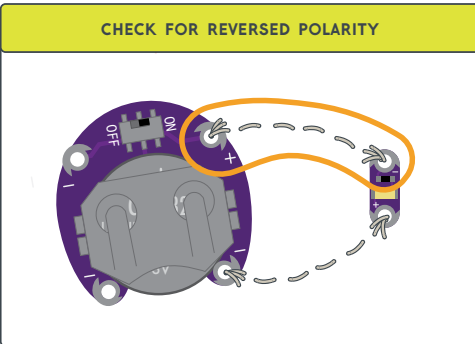

CHECK FOR DEAD BATTERY

Material in this section is copyright © 2013 by Leah Buechley, Kanjun Qiu, and Sonja de Boer under a Creative Commons Attribution-NonCommercial-ShareAlike License. Some rights reserved.

TROUBLESHOOTING

LilyMini ProtoSnap

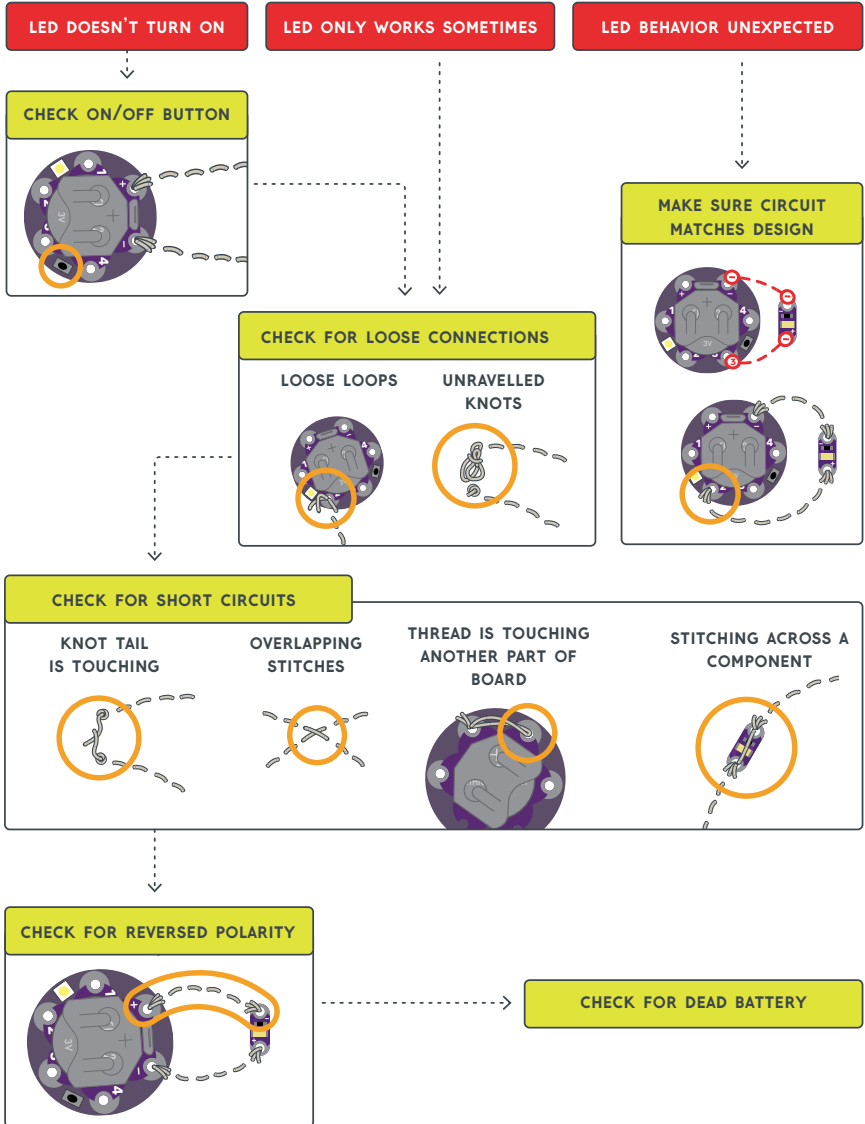

GLOSSARY

B **Button** – A type of switch that completes (closes) a circuit when pressed, then springs back to disconnect (open) the flow of electricity when released.

C **Circuit** – A continuous electrical loop that travels from the positive side of a power source along a path to components that use the electricity to function and back to the negative side of the power source. Also called a closed circuit.

Code – Sometimes called a “plan” or program, code is a set of instructions used by a microcontroller.

Conductive Thread – A specialty thread made with stainless steel fibers. It can be used instead of copper wiring to connect LilyPad (or other e-textile) components to create circuits.

Current – The flow of electricity in a circuit from the positive to negative sides of a power source. Current will not flow unless the circuit is a complete loop, meaning there are no short circuits or breaks in the electrical path between the power source and components along the way.

E **E-Sewing** (electronic sewing) – The process of using conductive thread to connect electronic components together.

E-Textiles (electronic textiles) – A type of prototyping that combines traditional craft processes with electrical engineering, computer science, and hardware skills. Many e-textile projects replace wiring with flexible conductive materials such as conductive threads and fabrics.

I **Input** – A sensor or signal that conveys information to a microcontroller.

L **LED** (Light-Emitting Diode) – A small device that turns on (lights up) when voltage is applied.

M **Microcontroller** – A small, programmable computer built onto a circuit board. The LilyMini is an example of a microcontroller built for sewable circuits. The LilyMini in this kit is pre-programmed.

N **Negative (-)** – The negative connection on a battery or hardware component, marked with a (-) sign. The return path for current flow in a circuit, sometimes referred to as ground.

O **Open Circuit** – A break in the circuit that causes the flow of electricity to stop. If your conductive thread traces leave a gap in the circuit, it will not work. Switches create open and closed circuits to control the flow of electricity and turn the circuit on or off.

Output – A component that can be controlled, such as an LED, buzzer, or motor. The LilyMini uses LEDs as outputs in Project 4 of this guide.

P **Parallel Circuit** – A type of circuit layout where positive (+) sides of multiple components are connected together, and negative (-) sides of the components are connected together. In this configuration, the electric current traveling from the battery is divided among components.

Polarity – Many electrical components have a specific orientation. Electric current can only flow in one direction through certain components, such as LEDs. Installing a component backward will halt the flow or function of the component. The connection points on LilyPad pieces are marked with (+) and (-) symbols to indicate how the piece should be installed in a circuit.

Positive (+) – The positive connection on a battery or hardware component, marked with a (+) sign. In a circuit, electric current flows from the power source's positive side through components to the negative side.

GLOSSARY

S Sew Tab – Silver-rimmed holes on LilyPad pieces where conductive thread can be connected, sometimes called petals or pins. The silver around the hole connects to the electrical components built into each LilyPad piece.

Short Circuit (“short”) – A direct, often accidental connection between power (+) and ground (–) of a power source. Electricity will flow quickly from power to ground, bypassing the rest of your circuit. A short between power and ground will drain the battery very quickly. Double check to make sure loose threads are not accidentally touching another part of your circuit.

Switch – An electronic component that controls how electric current flows by connecting or disconnecting its two sides. A switch turned to the ON position closes (completes) the circuit, allowing electricity to flow and, when turned OFF, opens or disconnects/interrupts current flow. A switch can be *momentary* – only connecting the two sides when held or pressed – or *maintained*, meaning the two sides are connected until the switch is moved to a different position. Switches are not polarized; either end can be connected to positive or negative.

T Trace – A pathway for electric current to flow through, made of a conductive material such as metal. The projects in this guide use conductive thread to create traces. On LilyPad ProtoSnap boards, the silver lines on the printed circuit boards are also traces.



SparkFun.com/LilyPadSewKit

LilyPad

LilyPad

SEWABLE
ELECTRONICS
KIT

The LilyPad Sewable Electronics Kit contains everything you need to complete four projects that use electronics to make your crafts come alive with lights, buttons, switches, and even a light sensor! No soldering or previous electronics experience necessary.



**GLOWING
PIN**



**ILLUMINATED
MASK**



**LIGHT-UP
PLUSH**



**NIGHT-LIGHT
PENNANT**

Ages 10+