

UF80B series



(80 x 80 x 25 mm)
3.15 x 3.15 x 0.98 inches

Operating voltage: 115 or 230 VAC

Construction: aluminum die cast frame;
UL94V-0 PBT impeller

Bearing option: ball bearing or sintered bronze sleeve

Motor: shaded pole

Air Flow: exhaust over struts

Connection: terminal or 22 AWG lead wire

Protection: impedance

Options: dual voltage 115/130VAC,
IP55; IP55 + salt fog

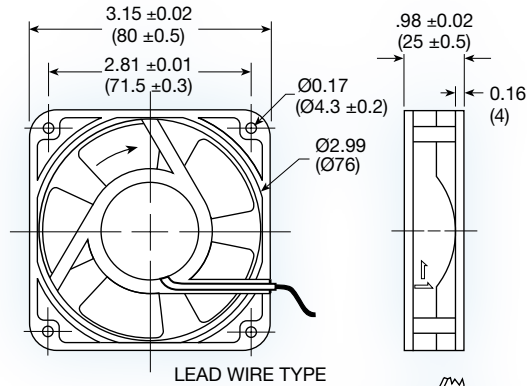

LEAD WIRE TYPE

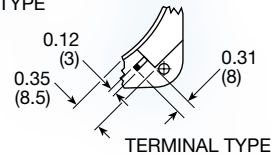

TERMINAL TYPE

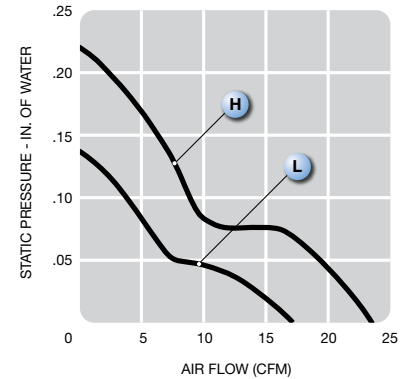

Model No.	Rated Voltage V	Freq. HZ	Input Power W	Rated Cur. A	Locked Cur. A	Speed RPM	Air Volume		Max. Static Pressure (H ₂ O)		Sound Noise dbA	Weight kg
							M ³ /Min.	CFM	MM	INCH		
UF80B12-__H	115	60	11	0.12	0.13	3,100	0.68	24	5.5	0.22	35	0.26
UF80B23-__H	230	60	14	0.07	0.08	3,100	0.68	24	5.5	0.22	35	0.26
UF80B12-__L	115	60	11	0.12	0.13	2,400	0.50	18	3.5	0.14	31	0.26
UF80B23-__L	230	60	14	0.06	0.07	2,400	0.50	18	3.5	0.14	31	0.26