

SMT Power Inductor

High Current Molded Power Inductor - PA4345.XXXNLT Series

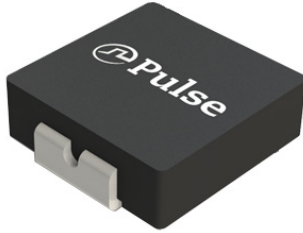

- Height:** 2.0mm Max
- Footprint:** 6.0mm x 5.4mm Max
- Current Rating:** up to 18.0A
- Inductance Range:** 0.1uH to 1.5uH
- Shielded construction and compact design
- High current, low DCR, and high efficiency
- Minimized acoustic noise and minimized leakage flux
- 200Vdc Isolation between terminal and core

Electrical Specifications @ 25°C - Operating Temperature -40°C to +125°C

Part Number	Inductance 100KHz, 1V uH	Rated Current A	DC Resistance		Saturation Current Max. A
			MAX.	TYP.	
			mΩ	mΩ	
PA4345.101NLT	0.10±30%	18.0	4.0	3.6	45.0
PA4345.151NLT	0.15±30%	16.0	4.6	3.8	27.0
PA4345.221NLT	0.22±20%	15.0	5.5	4.0	25.0
PA4345.241NLT	0.24±20%	13.0	7.0	6.0	23.0
PA4345.331NLT	0.33±20%	12.0	7.3	6.3	21.3
PA4345.471NLT	0.47±20%	11.5	8.6	7.3	18.0
PA4345.681NLT	0.68±20%	10.0	12.4	11.0	12.8
PA4345.102NLT	1.0±20%	7.0	20.0	17.5	13.7
PA4345.122NLT	1.2±20%	6.2	28.0	23.0	11.0
PA4345.152NLT	1.5±20%	5.5	30.5	26.5	9.8

- Notes:**
- Actual temperature of the component during system operation (ambient plus temperature rise) must be within the standard operating range.
 - The saturation current is the current at which the initial inductance drops approximately 30% at the stated ambient temperature. This current is determined by placing the component in the specified ambient environment and applying a short duration pulse current (to eliminate self-heating effect) to the component.
 - The rated current is the DC current required to raise the component temperature by approximately 40°C. Take note that the components' performance varies depending on the system condition. It is suggested that the component be tested at the system level, to verify the temperature rise of the component during system operation.
 - The part temperature (ambient+temp rise) should not exceed 125°C under worst case operating conditions. Circuit design, PCB trace size and thickness, airflow and other cooling provisions all affect the part temperature. Part temperature should be verified in the end application.

USA 858 674 8100

Germany 49 2354 777 100

Singapore 65 6287 8998

Shanghai 86 21 62787060

China 86 755 33966678

Taiwan 886 3 4356768

SMT Power Inductor

High Current Molded Power Inductor - PA4345.XXXNLT Series



Mechanical

PA4345.XXXNLT

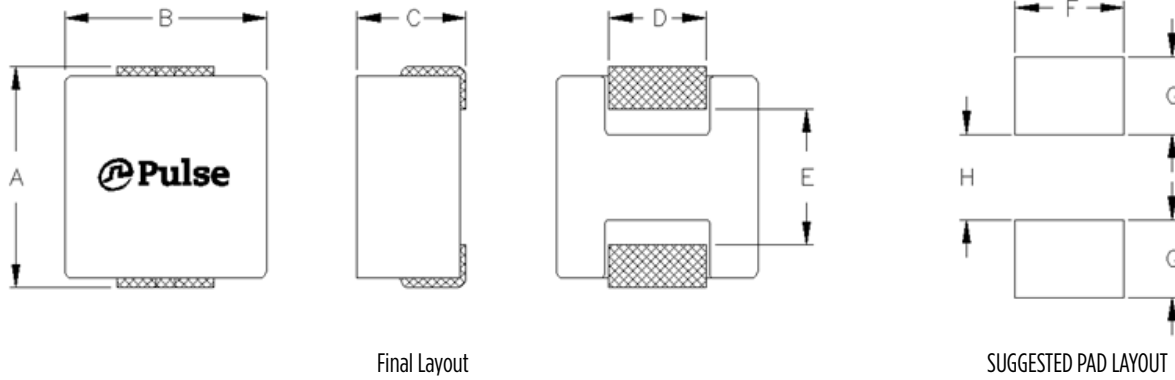

Series	A	B	C	D	E	F	G	H
PA4345.XXXNLT	6.0 Max	5.4 Max	2.0 Max	(2.5)	(3.5)	(2.8)	(2.0)	(2.2)

All Dimensions in mm.

TAPE & REEL INFO

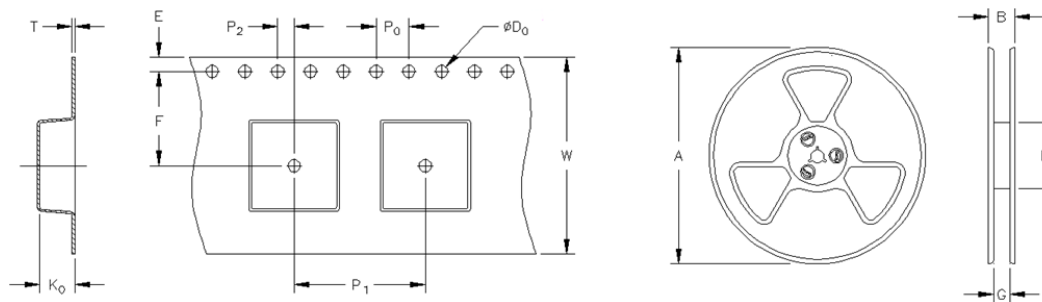

SURFACE MOUNTING TYPE, REEL/TAPE LIST

	REEL SIZE (mm)				TAPE SIZE (mm)									QTY
	A	B	G	N	E	F	D ₀	P ₁	P ₀	P ₂	W	T	K ₀	PCS/REEL
PA4345.XXXNLT	Ø330	N/A	12	100	1.75	5.5	1.5	8	4	2	12	0.35	2.3	3000

Typical Performance Curves

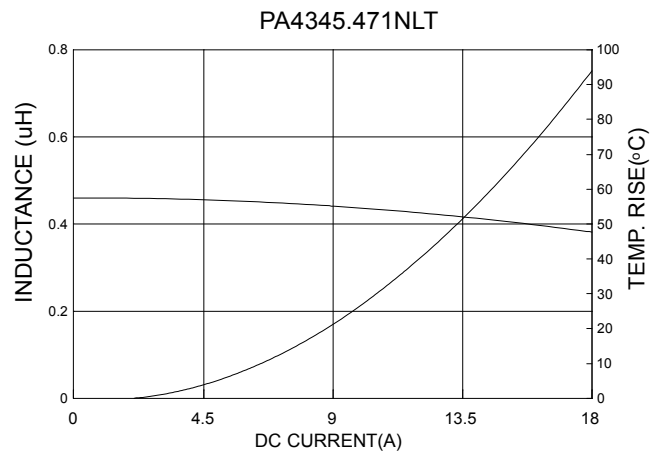
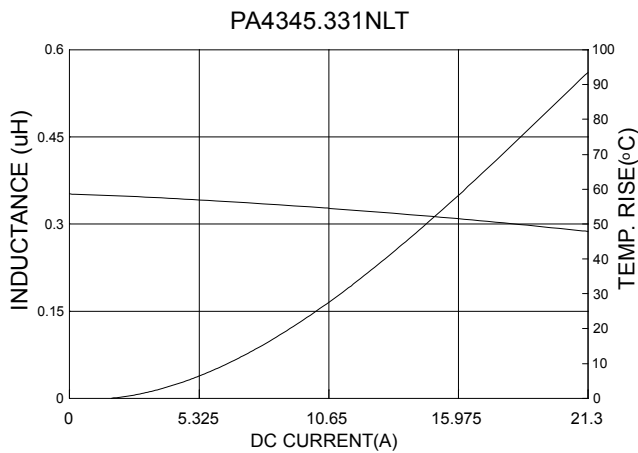
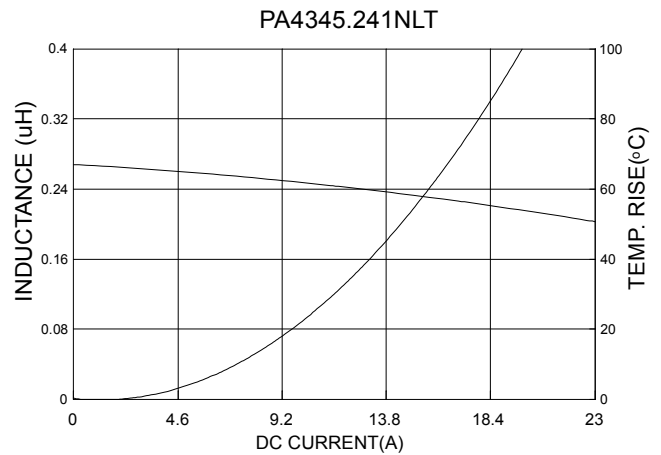
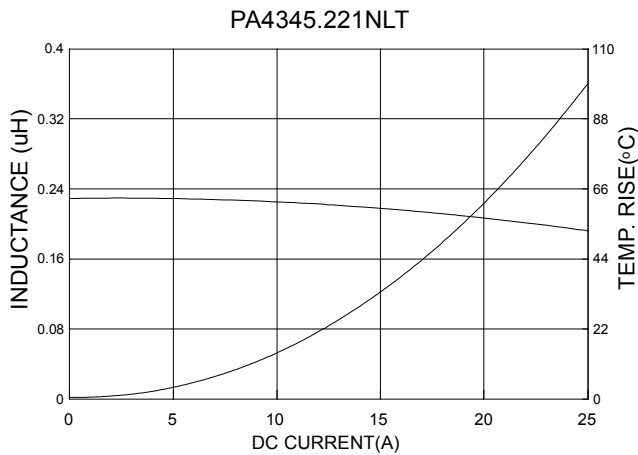
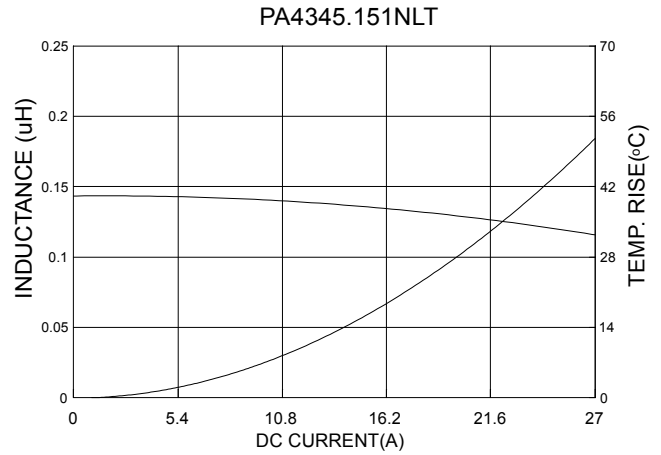
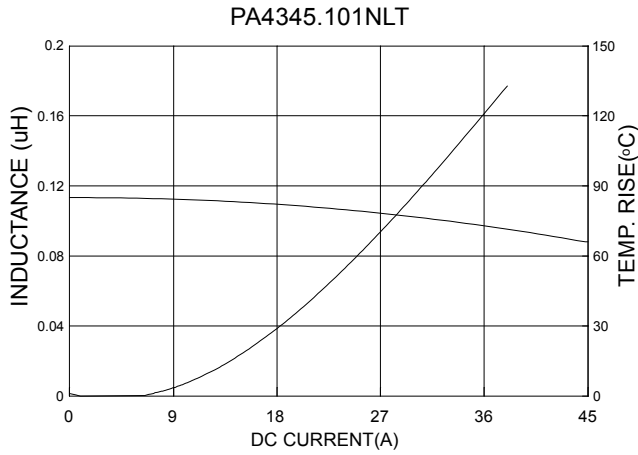

SMT Power Inductor

High Current Molded Power Inductor - PA4345.XXXNLT Series



PA4345.681NLT

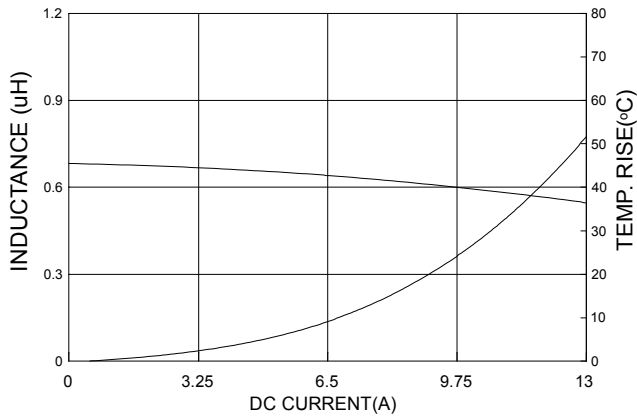

PA4345.102NLT

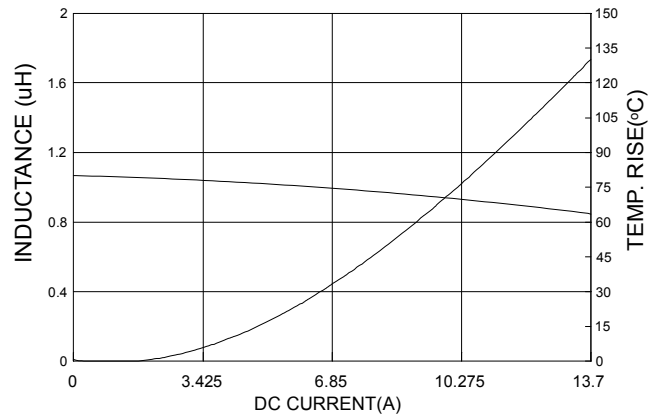

PA4345.122NLT

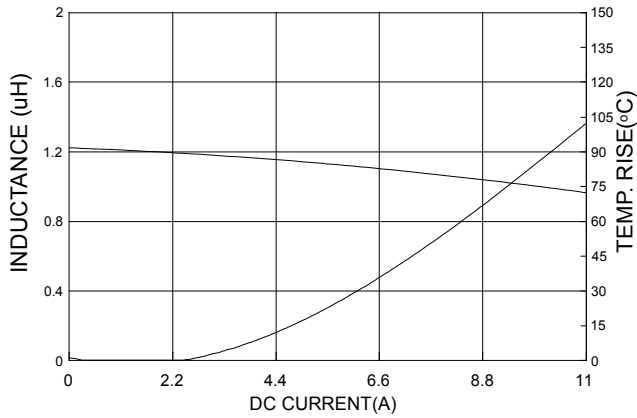

PA4345.152NLT

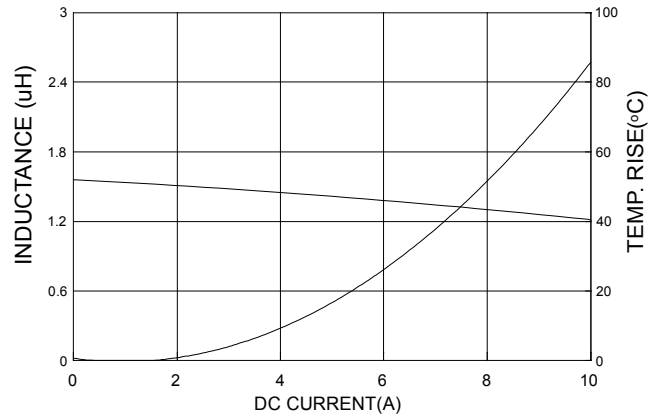

For More Information

Pulse Worldwide Headquarters

15255 Innovation Drive Ste 100
San Diego, CA 92128
U.S.A.

Tel: 858 674 8100
Fax: 858 674 8262

Pulse Europe

Pulse Electronics GmbH
Am Rottland 12
58540 Meinerzhagen
Germany

Tel: 49 2354 777 100
Fax: 49 2354 777 168

Pulse China Headquarters

B402, Shenzhen Academy of
Aerospace Technology Bldg.
10th Kejinan Road
High-Tech Zone
Nanshan District
Shenzhen, PR China 518057

Tel: 86 755 33966678
Fax: 86 755 33966700

Pulse North China

Room 2704/2705
Super Ocean Finance Ctr.
2067 Yan An Road West
Shanghai 200336
China

Tel: 86 21 62787060
Fax: 86 2162786973

Pulse South Asia

135 Joo Seng Road
#03-02
PM Industrial Bldg.
Singapore 368363

Tel: 65 6287 8998
Fax: 65 6287 8998

Pulse North Asia

3F, No. 198
Zhongyuan Road
Zhongli City
Taoyuan County 320
Taiwan R. O. C.

Tel: 886 3 4356768
Fax: 886 3 4356823 (Pulse)
Fax: 886 3 4356820 (FRE)

Performance warranty of products offered on this data sheet is limited to the parameters specified. Data is subject to change without notice. Other brand and product names mentioned herein may be trademarks or registered trademarks of their respective owners. © Copyright, 2017, Pulse Electronics, Inc. All rights reserved.